



OSTA Universal Disk Format Specification Revision 2.00

===== Readme =====

The pages included in this distribution are as follows:

UDF_200.PDF	Adobe Acrobat format of UDF Specification	2-132
HISTORY.TXT	Revision history of UDF Specification	133
UNICODE.C	Unicode sample source code	134-136
DOSNAME.C	UDF DOS filename translation	137-141
UDFTRANS.C	UDF OS/2, Macintosh and UNIX filename translation	142-146
FILE_ID.DIZ	BBS Description file	147

***** IMPORTANT NOTE *****

Please fill out the OSTA UDF Developer Registration form located in the UDF specification and return it to OSTA. This will make sure that you are kept up to date with announcements in regards to UDF.

For additional information on OSTA and UDF visit the OSTA web site at <http://www.osta.org>.

NOTE: Free Adobe Acrobat readers for several platforms are available at <http://www.adobe.com>

Universal Disk Format™ Specification

April 3rd, 1998
© Copyright 1994, 1995, 1996, 1997
Optical Storage Technology Association
ALL RIGHTS RESERVED

Revision History:

1.00	October 24, 1995	Original Release
1.01	November 3, 1995	DVD appendix added
1.02	August 30, 1996	Incorporates Document Change Notices DCN 2-001 through DCN 2-024
1.50	February 4, 1997	Integrated support for CD-R and CD-RW media (DCN 2-025 through DCN 2-032)
2.00	April 3, 1998	Integrated support for ECMA 167 3 rd Edition which included the support for named streams. (DCN 2-033 through DCN 2-064)

Optical Storage Technology Association
311 East Carrillo Street
Santa Barbara, CA 93101
(805) 963-3853 Voice
(805) 962-1541 Fax
info@osta.org
<http://www.osta.org>

This document along with the sample source code is available in electronic format from OSTA.

Important Notices

This document is a specification adopted by Optical Storage Technology Association (OSTA). This document may be revised by OSTA. It is intended solely as a guide for companies interested in developing products which can be compatible with other products developed using this document. OSTA makes no representation or warranty regarding this document, and any company using this document shall do so at its sole risk, including specifically the risks that a product developed will not be compatible with any other product or that any particular performance will not be achieved. OSTA shall not be liable for any exemplary, incidental, proximate or consequential damages or expenses arising from the use of this document. This document defines only one approach to compatibility, and other approaches may be available in the industry.

This document is an authorized and approved publication of OSTA. The underlying information and materials contained herein are the exclusive property of OSTA but may be referred to and utilized by the general public for any legitimate purpose, particularly in the design and development of writable optical systems and subsystems. This document may be copied in whole or in part provided that no revisions, alterations, or changes of any kind are made to the materials contained herein. Only OSTA has the right and authority to revise or change the material contained in this document, and any revisions by any party other than OSTA are totally unauthorized and specifically prohibited.

Compliance with this document may require use of one or more features covered by proprietary rights (such as features which are the subject of a patent, patent application, copyright, mask work right or trade secret right). By publication of this document, no position is taken by OSTA with respect to the validity or infringement of any patent or other proprietary right, whether owned by a Member or Associate of OSTA or otherwise. OSTA hereby expressly disclaims any liability for infringement of intellectual property rights of others by virtue of the use of this document. OSTA has not and does not investigate any notices or allegations of infringement prompted by publication of any OSTA document, nor does OSTA undertake a duty to advise users or potential users of OSTA documents of such notices or allegations. OSTA hereby expressly advises all users or potential users of this document to investigate and analyze any potential infringement situation, seek the advice of intellectual property counsel, and, if indicated, obtain a license under any applicable intellectual property right or take the necessary steps to avoid infringement of any intellectual property right. OSTA expressly disclaims any intent to promote infringement of any intellectual property right by virtue of the evolution, adoption, or publication of this OSTA document.

Universal Disk Format™ and UDF™ are trademarks of the Optical Storage Technology Association.

CONTENTS

1. INTRODUCTION.....	1
1.1 Document Layout.....	2
1.2 Compliance	3
1.3 General References	3
1.3.1 References.....	3
1.3.2 Definitions	4
1.3.3 Terms.....	6
2. BASIC RESTRICTIONS & REQUIREMENTS	7
2.1 Part 1 - General.....	9
2.1.1 Character Sets	9
2.1.2 OSTA CS0 CharSpec.....	10
2.1.3 Dstrings	10
2.1.4 Timestamp	11
2.1.5 Entity Identifier.....	12
2.2 Part 3 - Volume Structure	16
2.2.1 Descriptor Tag	16
2.2.2 Primary Volume Descriptor.....	17
2.2.3 Anchor Volume Descriptor.....	19
2.2.4 Logical Volume Descriptor.....	20
2.2.5 Unallocated Space Descriptor.....	22
2.2.6 Logical Volume Integrity Descriptor.....	22
2.2.7 Implementation Use Volume Descriptor.....	24
2.2.8 Virtual Partition Map.....	27
2.2.9 Sparable Partition Map.....	27
2.2.10 Virtual Allocation Table.....	28
2.2.11 Sparing Table.....	31
2.3 Part 4 - File System.....	34
2.3.1 Descriptor Tag	34
2.3.2 File Set Descriptor.....	35
2.3.3 Partition Header Descriptor	37
2.3.4 File Identifier Descriptor	38
2.3.5 ICB Tag	40
2.3.6 File Entry	42
2.3.7 Unallocated Space Entry.....	44
2.3.8 Space Bitmap Descriptor	45
2.3.9 Partition Integrity Entry	45
2.3.10 Allocation Descriptors.....	45
2.3.11 Allocation Extent Descriptor	47
2.3.12 Pathname	47
2.4 Part 5 - Record Structure.....	47

3.	SYSTEM DEPENDENT REQUIREMENTS.....	48
3.1	Part 1 - General.....	48
3.1.1	Timestamp	48
3.2	Part 3 - Volume Structure	49
3.2.1	Logical Volume Header Descriptor.....	49
3.3	Part 4 - File System.....	50
3.3.1	File Identifier Descriptor	50
3.3.2	ICB Tag	51
3.3.3	File Entry	53
3.3.4	Extended Attributes.....	56
3.3.5	Named Streams	66
3.3.6	Extended Attributes as named streams.....	68
3.3.7	UDF Defined System Streams.....	70
3.3.8	UDF Defined Non-System Streams.....	76
4.	USER INTERFACE REQUIREMENTS.....	78
4.1	Part 3 - Volume Structure	78
4.2	Part 4 - File System.....	78
4.2.1	ICB Tag	78
4.2.2	File Identifier Descriptor	79
5.	INFORMATIVE.....	87
5.1	Descriptor Lengths	87
5.2	Using Implementation Use Areas	87
5.2.1	Entity Identifiers	87
5.2.2	Orphan Space.....	87
5.3	Boot Descriptor.....	88
5.4	Technical Contacts	88
6.	APPENDICES	89
6.1	UDF Entity Identifier Definitions	89
6.2	UDF Entity Identifier Values	90
6.3	Operating System Identifiers	91
6.4	OSTA Compressed Unicode Algorithm	93
6.5	CRC Calculation.....	95
6.6	Algorithm for Strategy Type 4096	98

6.7	Identifier Translation Algorithms.....	99
6.7.1	DOS Algorithm.....	99
6.7.2	OS/2, Macintosh, Windows 95, Windows NT and UNIX Algorithm.....	103
6.8	Extended Attribute Checksum Algorithm	108
6.9	Requirements for DVD-ROM	109
6.9.1	Constraints imposed by UDF for DVD-Video	109
6.9.2	How to read a UDF disc.....	110
6.9.3	Obtaining DVD Documents.....	112
6.10	Recommendations for CD Media.....	113
6.10.1	Use of UDF on CD-R media	113
6.10.2	Use of UDF on CD-RW media.....	115
6.10.3	Multisession and Mixed Mode.....	118
6.11	UDF Media Format Revision History.....	121
6.12	Developer Registration Form.....	122

This page left intentionally blank

1. Introduction

The OSTA Universal Disk Format (UDF™) specification defines a subset of the standard ECMA 167 3rd edition. The primary goal of the OSTA UDF is to maximize data interchange and minimize the cost and complexity of implementing ECMA 167.

To accomplish this task this document defines a *Domain*. A domain defines rules and restrictions on the use of ECMA 167. The domain defined in this specification is known as the “OSTA UDF Compliant” domain.

This document attempts to answer the following questions for the structures of ECMA 167 on a per operating system basis:

Given some ECMA 167 structure X, for each field in structure X answer the following questions for a given operating system:

- 1) When reading this field: If the operating system supports the data in this field then what should it map to in the operating system?*
- 2) When reading this field: If the operating system supports the data in this field with certain limitations then how should the field be interpreted under this operating system?*
- 3) When reading this field: If the operating system does NOT support the data in this field then how should the field be interpreted under this operating system?*
- 4) When writing this field: If the operating system supports the data for this field then what should it map from in the operating system?*
- 5) When writing this field: If the operating system does NOT support the data for this field then to what value should the field be set?*

For some structures of ECMA 167 the answers to the above questions were self-explanatory and therefore those structures are not included in this document.

In some cases additional information is provided for each structure to help clarify the standard.

This document should help make the task of implementing the ECMA 167 standard easier.

To be informed of changes to this document please fill out and return the OSTA UDF Developers Registration Form located in appendix 6.12.

1.1 Document Layout

This document presents information on the treatment of structures defined under standard ECMA 167.

This document is separated into the following 4 basic sections:

- *Basic Restrictions and Requirements* - defines the restrictions and requirements which are operating system independent.
- *System Dependent Requirements* - defines the restrictions and requirements which are operating system dependent.
- *User Interface Requirements* - defines the restrictions and requirements which are related to the user interface.
- *Informative Annex* - Additional useful information.

This document presents information on the treatment of structures defined under standard ECMA 167. The following areas are covered:

↪ Interpretation of a structure/field upon reading from media.

↪ Contents of a structure/field upon writing to media. Unless specified otherwise *writing* refers only to creating a new structure on the media. When it applies to updating an existing structure on the media it will be specifically noted as such.

The fields of each structure are listed first, followed by a description of each field with respect to the categories listed above. In certain cases, one or more fields of a structure are not described if the semantics associated with the field are obvious.

A word on terminology: in common with ECMA 167, this document will use *shall* to indicate a mandatory action or requirement, *may* to indicate an optional action or requirement, and *should* to indicate a preferred, but still optional action or requirement.

Also, special comments associated with fields and/or structures are prefaced by the notification: "**NOTE:**"

1.2 Compliance

This document requires conformance to parts 1, 2, 3 and 4 of ECMA 167. Compliance to part 5 of ECMA 167 is not supported by this document. Part 5 may be supported in a later revision of this document.

For an implementation to claim compliance to this document the implementation shall meet all the requirements (indicated by the word *shall*) specified in this document.

The following are a few points of clarification in regards to compliance:

- *Multi-Volume support is optional.* An implementation can claim compliance and only support single volumes.
- *Multi-Partition support is optional.* An implementation can claim compliance without supporting the special multi-partition case on a single volume defined in this specification.
- *Media support.* An implementation can claim compliance and support a single media type or any combination. All implementations should be able to read any media that is physically accessible.
- *Multisession support.* Any implementation that supports reading of CD-R media shall support reading of CD-R Multisessions as defined in 6.10.3.
- *File Name Translation* - Any time an implementation has the need to transform a filename to meet operating system restrictions it shall use the algorithms specified in this document.
- *Extended Attributes* - All compliant implementations shall preserve existing extended attributes encountered on the media. Implementations shall create and maintain the extended attributes for the operating systems they support. For example, an implementation that supports Macintosh shall preserve any OS/2 extended attributes encountered on the media. An implementation that supports Macintosh shall also create and maintain all Macintosh extended attributes specified in this document.
- *Backwards Read Compatibility* – A compliant UDF 2.00 implementation *shall* be able to *read* all media written under UDF 1.50 and 1.02.
- *Backwards Write Compatibility* – UDF 2.00 structures shall not be written to media which contains UDF 1.50 or UDF 1.02 structures. UDF 1.50 and UDF 1.02 structures shall not be written to media which contains UDF 2.00 structures. These two requirements prevent media from containing different versions of the UDF structures.

1.3 General References

1.3.1 References

<i>ISO 9660:1988</i>	Information Processing - Volume and File Structure of CD-ROM for Information Interchange
<i>IEC 908:1987</i>	Compact disc digital audio system

<i>ISO/IEC 10149:1993</i>	Information technology - Data Interchange on read-only 120mm optical data discs (CD-ROM based on the Philips/Sony “Yellow Book”)
<i>Orange Book part-II</i>	Recordable Compact Disc System Part-II, N.V. Philips and Sony Corporation
<i>Orange Book part-III</i>	Recordable Compact Disc System Part-III, N.V. Philips and Sony Corporation
<i>ISO/IEC 13346:1995</i>	Volume and file structure of write-once and rewritable media using non-sequential recording for information interchange. This ISO standard is equivalent to ECMA 167 2 nd edition..
<i>ECMA 167</i>	ECMA 167 3 rd edition is an update to ECMA 167 2 nd edition that adds the support for multiple data stream files, and is available from http://www.ecma.ch . The previous edition of ECMA 167 (2 nd) was is equivalent to ISO/IEC 13346:1995. References enclosed in [] in this document are references to ECMA 167 3 rd edition. The references are in the form [x/a.b.c], where x is the section number and a.b.c is the paragraph or figure number.

1.3.2 Definitions

<i>Audio session</i>	Audio session contains one or more audio tracks, and no data track.
<i>Audio track</i>	Audio tracks are tracks that are designated to contain audio sectors specified in ISO/IEC 908.
<i>CD-R</i>	CD-Recordable. A write once CD defined in Orange Book, part-II.
<i>CD-RW</i>	CD-Rewritable. An overwritable CD defined in Orange Book, part-III.
<i>Clean File System</i>	The file system on the media conforms to this specification.
<i>Data track</i>	Data tracks are tracks that are designated to contain data sectors specified in ISO/IEC 10149.
<i>Dirty File System</i>	A file system that is not a clean file system.
<i>Fixed Packet</i>	An incremental recording method in which all packets in a given track are of a length specified in the Track Descriptor Block. Addresses presented to a CD drive are translated according to the Method 2 addressing specified in Orange Book parts-II and -III.
<i>ICB</i>	A control node in ECMA 167.
<i>Logical Block Address</i>	A logical block number [3/8.8.1]. NOTE 1: This is not to be confused with a logical block address [4/7.1], given by the lb_addr structure which contains both a logical block number [3/8.8.1] and a partition reference number [3/8.8], the latter identifying the partition [3/8.7] which contains the addressed logical block [3/8.8.1]. NOTE 2: A logical block number [3/8.8.1] translates to a logical sector number [3/8.1.2] according to the scheme indicated by the partition map [3/10.7] of the partition [3/8.7] which contains the addressed logical block [3/8.8.1]
<i>Media Block Address</i>	A sector number [3/8.1.1], derived from the unique sector address given by a relevant standard for recording [1/5.10]. In this specification, a sector number [3/8.1.1] is equivalent to a logical sector number [3/8.1.2].

<i>Packet</i>	A recordable unit, which is an integer number of contiguous sectors [1/5.9], which consist of user data sectors, and may include additional sectors [1/5.9] which are recorded as overhead of the Packet-writing operation and are addressable according to the relevant standard for recording [1/5.10].
<i>Physical Address</i>	A sector number [3/8.1.1], derived from the unique sector address given by a relevant standard for recording [1/5.10]. In this specification, a sector number [3/8.1.1] is equivalent to a logical sector number [3/8.1.2].
<i>Physical Block Address</i>	A sector number [3/8.1.1], derived from the unique sector address given by a relevant standard for recording [1/5.10]. In this specification, a sector number [3/8.1.1] is equivalent to a logical sector number [3/8.1.2].
<i>physical sector</i>	A sector [1/5.9] given by a relevant standard for recording [1/5.10]. In this specification, a sector [1/5.9] is equivalent to a a logical sector [3/8.1.2].
<i>Random Access File System</i>	A file system for randomly writable media, either write once or rewritable
<i>Sequential File System</i>	A file system for sequentially written media (e.g. CD-R)
<i>Session</i>	The tracks of a volume shall be organized into one or more sessions as specified by the Orange Book part-II. A session shall be a sequence of one or more tracks, the track numbers of which form a contiguous ascending sequence.
<i>Track</i>	The sectors of a volume shall be organized into one or more tracks. A track shall be a sequence of sectors, the sector numbers of which form a contiguous ascending sequence. No sector shall belong to more than one track. Note: There may be gaps between tracks; that is, the last sector of a track need not be adjacent to the first sector of the next track.
<i>UDF</i>	OSTA Universal Disk Format
<i>user data blocks</i>	The logical blocks [3/8.8.1] which were recorded in the sectors [1/5.9] (equivalent in this specification to logical sectors [3/8.1.2]) of a Packet and which contain the data intentionally recorded by the user of the drive. This specifically does not include the logical blocks [3/8.8.1], if any, whose constituent sectors [1/5.9] were used for the overhead of recording the Packet, even though those sectors [1/5.9] are addressable according to the relevant standard for recording [1/5.10]. Like any logical blocks [3/8.8.1], user data blocks are identified by logical block numbers [3/8.8.1].
<i>user data sectors</i>	The sectors [1/5.9] of a Packet which contain the data intentionally recorded by the user of the drive, specifically not including those sectors [1/5.9] used for the overhead of recording the Packet, even though those sectors [1/5.9] may be addressable according to the relevant standard for recording [1/5.10]. Like any sectors [1/5.9], user data sectors are identified by sector numbers [3/8.1.1]. In this specification, a sector number [3/8.1.1] is equivalent to a a logical sector number [3/8.1.2].

<i>Variable Packet</i>	An incremental recording method in which each packet in a given track is of a host determined length. Addresses presented to a CD drive are as specified in Method 1 addressing in Orange Book parts II and III.
<i>Virtual Address</i>	A logical block number [3/8.8.1] of a logical block [3/8.8.1] in a virtual partition. Such a logical block [3/8.8.1] is recorded using the space of a logical block [3/8.8.1] of a corresponding non-virtual partition. The Nth Uint32 in the VAT represents the logical block number [3/8.8.1] in a non-virtual partition used to record logical block number N of its corresponding virtual partition. The first virtual address is 0.
<i>virtual partition</i>	A partition of a logical volume [3/8.8] identified in a logical volume descriptor [3/10.6] by a Type 2 partition map [3/10.7.3] recorded according section 2.2.8 of to this specification. The virtual partition map contains a partition number which is the same as the partition number [3/10.7.2.4] in a Type 1 partition map [3/10.7.2] in the same logical volume descriptor [3/10.6]. Each logical block [3/8.8.1] in the virtual partition is recorded using the space of a logical block [3/8.8.1] of that corresponding non-virtual partition. A VAT lists the logical blocks [3/8.8.1] of the non-virtual partition which have been used to record the logical blocks [3/8.8.1] of its corresponding virtual partition.
<i>virtual sector</i>	A logical block [3/8.8.1] in a virtual partition. Such a logical block [3/8.8.1] is recorded using the space of a logical block [3/8.8.1] of a corresponding non-virtual partition. A virtual sector should not be confused with a sector [1/5.9] or a logical sector [3/8.1.2].
<i>VAT</i>	A file [4/8.8] recorded in the space of a non-virtual partition which has a corresponding virtual partition, and whose data space [4/8.8.2] is structured according to section 2.2.10 of this specification. This file provides an ordered list of Uint32s, where the Nth Uint32 represents the logical block number [3/8.8.1] of a non-virtual partition used to record logical block number N of its corresponding virtual partition. This file [4/8.8] is not necessarily referenced by a file identifier descriptor [4/14.4] of a directory [4/8.6] in the file set [4/8.5] of the logical volume [3/8.8].
<i>VAT ICB</i>	A File Entry ICB that describes a file containing a Virtual Allocation Table.

1.3.3 Terms

<i>May</i>	Indicates an action or feature that is optional.
<i>Optional</i>	Describes a feature that may or may not be implemented. If implemented, the feature shall be implemented as described.
<i>Shall</i>	Indicates an action or feature that is mandatory and must be implemented to claim compliance to this standard.
<i>Should</i>	Indicates an action or feature that is optional, but its implementation is strongly recommended.
<i>Reserved</i>	A reserved field is reserved for future use and shall be set to zero. A reserved value is reserved for future use and shall not be used.

2. Basic Restrictions & Requirements

The following table summarizes several of the basic restrictions and requirements defined in this specification. These restrictions & requirements as well as additional ones are described in detail in the following sections of this specification.

Item	Restrictions & Requirements
Logical Sector Size	The <i>Logical Sector Size</i> for a specific volume shall be the same as the physical sector size of the specific volume.
Logical Block Size	The <i>Logical Block Size</i> for a Logical Volume shall be set to the logical sector size of the volume or volume set on which the specific logical volume resides.
Volume Sets	All media within the same Volume Set shall have the same physical sector size. Rewritable/Overwritable media and WORM media shall not be mixed in/ be present in the same volume set.
First 32K of Volume Space	The first 32768 bytes of the Volume space shall not be used for the recording of ECMA 167 structures. This area shall not be referenced by the Unallocated Space Descriptor or any other ECMA 167 descriptor. This is intended for use by the native operating system.
Volume Recognition Sequence	The Volume Recognition Sequence as described in part 2 of ECMA 167 shall be recorded.
Timestamp	All timestamps shall be recorded in local time. Time zones shall be recorded on operating systems that support the concept of a time zone.
Entity Identifiers	Entity Identifiers shall be recorded in accordance with this document. Unless otherwise specified in this specification the Entity Identifiers shall contain a value that uniquely identifies the implementation.
Descriptor CRCs	CRCs shall be supported and calculated for all Descriptors, except for the Space Bitmap Descriptor.
File Name Length	Maximum of 255 bytes
Maximum Pathsize	Maximum of 1023 bytes
Extent Length	Maximum Extent Length shall be 2^{30} - <i>Logical Block Size</i> . Maximum Extent Length for extents in virtual space shall be the Logical Block Size.
Primary Volume Descriptor	There shall be exactly one prevailing Primary Volume Descriptor recorded per volume.
Anchor Volume Descriptor Pointer	Shall be recorded in at least 2 of the following 3 locations: 256, N-256, or N, where N is the last addressable sector of a volume.
Partition Descriptor	A Partition Access Type of Read-Only, Rewritable, Overwritable and WORM shall be supported. There shall be exactly one type 1 prevailing Partition Descriptor recorded per volume, with one exception. For Volume Sets that consist of single volume, the volume may contain 2 Partitions with 2 prevailing Partition Descriptors only if one has an access type of read only and the other has an access type of Rewritable or Overwritable, or

	WORM. The Logical Volume for this volume would consist of the contents of both partitions.
Logical Volume Descriptor	<p>There shall be exactly one prevailing Logical Volume Descriptor recorded per Volume Set.</p> <p>The <i>LogicalVolumeIdentifier</i> field shall not be null and should contain a identifier that aids in the identification of the logical volume. Specifically, software generating volumes conforming to this specification shall not set this field to a fixed or trivial value. Duplicate disks which are intended to be identical may contain the same value in this field. This field is extremely important in logical volume identification when multiple media are present within a jukebox. This name is typically what is displayed to the user.</p>
Logical Volume Integrity Descriptor	Shall be recorded. The extent of LVIDs may be terminated by the extent length.
Unallocated Space Descriptor	A single prevailing Unallocated Space Descriptor shall be recorded per volume.
File Set Descriptor	There shall be exactly one File Set Descriptor recorded per Logical Volume on Rewritable/Overwritable media. For WORM media multiple File Set Descriptors may be recorded based upon certain restrictions defined in this document. The <i>File Set Identifier</i> field of the File Set Descriptor contains a name that may be used as an alias name for identifying the Logical Volume to the user. See 2.3.2.7 for further details. The FSD extent may be terminated by the extent length.
ICB Tag	Only strategy types 4 or 4096 shall be recorded.
File Identifier Descriptor	The total length of a <i>File Identifier Descriptor</i> shall not exceed the size of one Logical Block.
File Entry	The total length of a <i>File Entry</i> shall not exceed the size of one Logical Block.
Allocation Descriptors	Only Short and Long Allocation Descriptors shall be recorded.
Allocation Extent Descriptors	The length of any single <i>Allocation Extent Descriptor</i> shall not exceed the <i>Logical Block Size</i> .
Unallocated Space Entry	The total length of an <i>Unallocated Space Entry</i> shall not exceed the size of one Logical Block.
Space Bitmap Descriptor	CRC not required.
Partition Integrity Entry	Shall not be recorded.
Volume Descriptor Sequence Extent	Both the main and reserve volume descriptor sequence extents shall each have a minimum length of 16 logical sectors. The VDS Extent may be terminated by the extent length.
Record Structure	Record structure files, as defined in part 5 of ECMA 167, shall not be created.

2.1 Part 1 - General

2.1.1 Character Sets

The character set used by UDF for the structures defined in this document is the CS0 character set. The OSTA CS0 character set is defined as follows:

OSTA CS0 shall consist of the d-characters specified in the The Unicode Standard, Version 2.0 (ISBN 0-201-48345-9 from Addison-Wesley Publishing Company <http://www.aw.com/devpress>, see also <http://www.unicode.org>), excluding #FEFF and FFFE, stored in the *OSTA Compressed Unicode* format which is defined as follows:

OSTA Compressed Unicode format

RBP	Length	Name	Contents
0	1	Compression ID	UInt8
1	??	Compressed Bit Stream	byte

The *CompressionID* shall identify the compression algorithm used to compress the *CompressedBitStream* field. The following algorithms are currently supported:

Compression Algorithm

Value	Description
0 - 7	Reserved
8	Value indicates there are 8 bits per character in the <i>CompressedBitStream</i> .
9-15	Reserved
16	Value indicates there are 16 bits per character in the <i>CompressedBitStream</i> .
17-253	Reserved
254	Value indicates there is a unique 4-byte binary number following.
255	Value indicates there is a unique 8-byte binary number following.

For a *CompressionID* of 8 or 16, the value of the *CompressionID* shall specify the number of *BitsPerCharacter* for the d-characters defined in the *CharacterBitStream* field. Each sequence of *CompressionID* bits in the *CharacterBitStream* field shall represent an *OSTA Compressed Unicode* d-character. The bits of the character being encoded shall be added to the *CharacterBitStream* from most- to least-significant-bit. The bits shall be added to the *CharacterBitStream* starting from the most-significant-bit of the current byte being encoded into.

NOTE: This encoding causes characters written with a *CompressionID* of 16 to be effectively written in big endian format.

The value of the *OSTA Compressed Unicode* d-character interpreted as a Uint16 defines the value of the corresponding d-character in the Unicode 2.0 standard. Refer to appendix on *OSTA Compressed Unicode* for sample C source code to convert between *OSTA Compressed Unicode* and standard Unicode 2.0.

The Unicode byte-order marks, #FEFF and #FFFE, shall not be used.

A Compression ID of 254 or 255 shall indicate that the following 4 or 8 bytes respectively contain a binary value unique to the context. E.g. File Identifiers may use a Compression ID of 254 or 255 and a byte offset of the FID within the directory to create unique directory entries when the Deleted bit is set.

2.1.2 OSTA CS0 CharSpec

```
struct charspec {           /* ECMA 167 1/7.2.1 */
    Uint8                   CharacterSetType;
    byte                    CharacterSetInfo[63];
}
```

The *CharacterSetType* field shall have the value of 0 to indicate the CS0 coded character set.

The *CharacterSetInfo* field shall contain the following byte values with the remainder of the field set to a value of 0.

#4F, #53, #54, #41, #20, #43, #6F, #6D, #70, #72, #65, #73, #73, #65,
#64, #20, #55, #6E, #69, #63, #6F, #64, #65

The above byte values represent the following ASCII string:
“OSTA Compressed Unicode”

2.1.3 Dstrings

The ECMA 167 standard, as well as this document, has normally defined byte positions relative to 0. In section 7.2.12 of ECMA 167, dstrings are defined in terms of being relative to 1. Since this offers an opportunity for confusion, the following shows what the definition would be if described relative to 0.

7.2.12 Fixed-length character fields

A dstring of length *n* is a field of *n* bytes where d-characters (1/7.2) are recorded. The number of bytes used to record the characters shall be recorded as a Uint8 (1/7.1.1) in byte *n-1*, where *n* is the length of the field. The characters shall be recorded starting with the first byte of the field, and any remaining byte positions after the characters up until byte *n-2* inclusive shall be set to #00.

If the number of d-characters to be encoded is zero, the length of the dstring shall be zero.
NOTE: The length of a dstring includes the compression code byte(2.1.1) except for the case of a zero length string. A zero length string shall be recorded by setting the entire dstring field to all zeros.

2.1.4 Timestamp

```
struct timestamp { /* ECMA 167 1/7.3 */
    Uint16    TypeAndTimezone;
    Uint16    Year;
    Uint8     Month;
    Uint8     Day;
    Uint8     Hour;
    Uint8     Minute;
    Uint8     Second;
    Uint8     Centiseconds;
    Uint8     HundredsofMicroseconds;
    Uint8     Microseconds;
}
```

2.1.4.1 Uint16 TypeAndTimezone;

For the following descriptions *Type* refers to the most significant 4 bits of this field, and *TimeZone* refers to the least significant 12 bits of this field.

- ☞ The time within the structure shall be interpreted as Local Time since *Type* shall be equal to ONE for OSTA UDF compliant media.
- ☞ *Type* shall be set to ONE to indicate Local Time.
- ☞ Shall be interpreted as specifying the time zone for the location when this field was last modified. If this field contains -2047 then the time zone has not been specified.
- ☞ For operating systems that support the concept of a time zone, the offset of the time zone (in 1 minute increments), from Coordinated Universal Time, shall be inserted in this field. Otherwise the time zone portion of this field shall be set to -2047.

Note: Time zones West of Coordinated Universal Time have negative offsets. For example, Eastern Standard Time is -300 minutes; Eastern Daylight Time is -240 minutes.

2.1.5 Entity Identifier

```
struct EntityID { /* ECMA 167 1/7.4 */
    Uint8      Flags;
    char       Identifier[23];
    char       IdentifierSuffix[8];
}
```

UDF classifies *Entity Identifiers* into 3 separate types as follows:

- *Domain Entity Identifiers*
- *UDF Entity Identifiers*
- *Implementation Entity Identifiers*

The following sections describes the format and use of *Entity Identifiers* based upon the different types mentioned above.

2.1.5.1 Uint8 Flags

 Self explanatory.

 Shall be set to ZERO.

2.1.5.2 char Identifier

Unless stated otherwise in this document this field shall be set to an identifier that uniquely identifies the implementation. This methodology will allow for identification of the implementation responsible for creating structures recorded on media interchanged between different implementations.

If an implementation updates existing structures on the media written by other implementations the updating implementation shall set the *Identifier* field to a value that uniquely identifies the updating implementation.

The following table summarizes the *Entity Identifier* fields defined in the ECMA 167 standard and this document and shows to what values they shall be set.

Entity Identifiers

Descriptor	Field	ID Value	Suffix Type
Primary Volume Descriptor	Implementation ID	“*Developer ID”	Implementation Identifier Suffix
Implementation Use Volume Descriptor	Implementation ID	“*Developer ID”	Implementation Identifier Suffix
Implementation Use Volume Descriptor	Implementation Identifier	“*UDF LV Info”	UDF Identifier Suffix
Partition Descriptor	Implementation ID	“*Developer ID”	Implementation Identifier Suffix

Logical Volume Descriptor	Implementation ID	“*Developer ID”	Implementation Identifier Suffix
Logical Volume Descriptor	Domain ID	“*OSTA UDF Compliant”	DOMAIN Identifier Suffix
File Set Descriptor	Domain ID	“*OSTA UDF Compliant”	DOMAIN Identifier Suffix
File Identifier Descriptor	Implementation ID	“*Developer ID”	Implementation Identifier Suffix (optional)
File Entry	Implementation ID	“*Developer ID”	Implementation Identifier Suffix
UDF Extended Attribute	Implementation ID	See Appendix	UDF Identifier Suffix
Non-UDF Extended Attribute	Implementation ID	“*Developer ID”	Implementation Identifier Suffix
Device Specification Extended Attribute	Implementation ID	“*Developer ID”	Implementation Identifier Suffix
Logical Volume Integrity Descriptor	Implementation ID	“*Developer ID”	Implementation Identifier Suffix
Partition Integrity Entry	Implementation ID	N/A	N/A
Virtual Partition Map	Partition Type Identifier	“*UDF Virtual Partition”	UDF Identifier Suffix
Sparable Partition Map	Partition Type Identifier	“*UDF Sparable Partition”	UDF Identifier Suffix
Virtual Allocation Table	Entity ID	“*UDF Virtual Alloc Tbl”	UDF Identifier Suffix
Sparing Table	Sparing Identifier	“*UDF Sparing Table”	UDF Identifier Suffix

NOTE: The value of the Entity Identifier field is interpreted as a sequence of bytes, and not as a dstring specified in CS0. For ease of use the values used by UDF for this field are specified in terms of ASCII character strings. The actual sequence of bytes used for the Entity Identifiers defined by UDF are specified in the appendix.

In the *ID Value* column in the above table “*Developer ID” refers to a Entity Identifier that uniquely identifies the current implementation. The value specified should be used when a new descriptor is created. Also, the value specified should be used for an existing descriptor when anything within the scope of the specified EntityID field is modified.

NOTE: The value chosen for a “*Developer ID” should contain enough information to identify the company and product name for an implementation. For example, a company called XYZ with a UDF product called *DataOne* might choose “*XYZ DataOne” as their developer ID. Also in the suffix of their developer ID they may choose to record the current version number of their *DataOne* product. This information is extremely helpful when trying to determine which

implementation wrote a bad structure on a piece of media when multiple products from different companies have been recording on the media.

The *Suffix Type* column in the above table defines the format of the suffix to be used with the corresponding Entity Identifier. These different suffix types are defined in the following paragraphs.

NOTE: All *Identifiers* defined in this document (appendix 6.1) shall be registered by OSTA as UDF *Identifiers*.

2.1.5.3 IdentifierSuffix

The format of the *IdentifierSuffix* field is dependent on the type of the *Identifier*.

In regard to OSTA Domain *Entity Identifiers* specified in this document (appendix 6.1) the *IdentifierSuffix* field shall be constructed as follows:

Domain IdentifierSuffix field format

RBP	Length	Name	Contents
0	2	UDF Revision	UInt16 (= #0200)
2	1	Domain Flags	UInt8
3	5	Reserved	bytes (= #00)

The *UDFRevision* field shall contain **#0200** to indicate revision **2.00** of this document. This field will allow an implementation to detect changes made in newer revisions of this document. The OSTA Domain Identifiers are only used in the Logical Volume Descriptor and the File Set Descriptor. The *DomainFlags* field defines the following bit flags:

Domain Flags

Bit	Description
0	Hard Write-Protect
1	Soft Write-Protect
2-7	Reserved

The *SoftWriteProtect* flag is a user settable flag that indicates that the volume or file system structures within the scope of the descriptor in which it resides are write protected. A *SoftWriteProtect* flag value of ONE shall indicate user write protected structures. This flag may be set or reset by the user. The *HardWriteProtect* flag is an implementation settable flag that indicates that the scope of the descriptor in which it resides is permanently write protected. A *HardWriteProtect* flag value of ONE shall indicate a permanently write protected structure. Once set this flag shall not be reset. The *HardWriteProtect* flag overrides the *SoftWriteProtect* flag.

The write protect flags appear in the Logical Volume Descriptor and in the File Set Descriptor. They shall be interpreted as follows:

```

is_fileset_write_protected = LVD.HardWriteProtect || LVD.SoftWriteProtect ||
    FSD.HardWriteProtect || FSD.SoftWriteProtect
is_fileset_hard_protected = LVD.HardWriteProtect || FSD.HardWriteProtect
is_fileset_soft_protected = (LVD.SoftWriteProtect || FSD.SoftWriteProtect) &&
    (! is_vol_hard_protected)
is_vol_write_protected = LVD.HardWriteProtect || LVD.SoftWriteProtect
is_vol_hard_protected = LVD.HardWriteProtect
is_vol_soft_protected = LVD.SoftWriteProtect && !LVD.HardWriteProtect

```

Implementation use *Entity Identifiers* defined by UDF (appendix 6.1) the *IdentifierSuffix* field shall be constructed as follows:

UDF *IdentifierSuffix*

RBP	Length	Name	Contents
0	2	UDF Revision	UInt16 (= #0200)
2	1	OS Class	UInt8
3	1	OS Identifier	UInt8
4	4	Reserved	bytes (= #00)

The contents of the *OS Class* and *OS Identifier* fields are described in the Appendix on *Operating System Identifiers*.

For implementation use *Entity Identifiers* not defined by UDF the *IdentifierSuffix* field shall be constructed as follows:

Implementation *IdentifierSuffix*

RBP	Length	Name	Contents
0	1	OS Class	UInt8
1	1	OS Identifier	UInt8
2	6	Implementation Use Area	bytes

NOTE: It is important to understand the intended use and importance of the *OS Class* and *OS Identifier* fields. The main purpose of these fields is to aid in debugging when problems are found on a UDF volume. The fields also provide useful information which could be provided to the end user. When set correctly these two fields provide an implementation with information such as the following:

- Identify under which operating system a particular structure was last modified.
- Identify under which operating system a specific file or directory was last modified.
- If a developer supports multiple operating systems with their implementation, it helps to determine under which operating system a problem may have occurred.

2.2 Part 3 - Volume Structure

2.2.1 Descriptor Tag

```
struct tag { /* ECMA 167 3/7.2 */
    Uint16 TagIdentifier;
    Uint16 DescriptorVersion;
    Uint8 TagChecksum;
    byte Reserved;
    Uint16 TagSerialNumber;
    Uint16 DescriptorCRC;
    Uint16 DescriptorCRCLength;
    Uint32 TagLocation;
}
```

2.2.1.1 Uint16 TagSerialNumber

☞ Ignored. Intended for disaster recovery.

☞ Reset to a unique value at volume initialization.

The *TagSerialNumber* shall be set to a value that differs from ones previously recorded, upon volume re-initialization. It is suggested that: $TagSerialNumber = ((TagSerialNumber \text{ of the Primary Volume Descriptor}) + 1)$.

2.2.1.2 Uint16 DescriptorCRCLength

CRCs shall be supported and calculated for each descriptor. The value of this field shall be set to (Size of the Descriptor) - (Length of Descriptor Tag). When reading a descriptor the CRC should be validated.

2.2.1.3 Uint32 TagLocation

For structures referenced via a virtual address (i.e. referenced through the VAT), this value shall be the virtual address, not the physical or logical address.

2.2.2 Primary Volume Descriptor

```
struct PrimaryVolumeDescriptor { /* ECMA 167 3/10.1 */
    struct tag      DescriptorTag;
    Uint32          VolumeDescriptorSequenceNumber;
    Uint32          PrimaryVolumeDescriptorNumber;
    dstring         VolumeIdentifier[32];
    Uint16          VolumeSequenceNumber;
    Uint16          MaximumVolumeSequenceNumber;
    Uint16          InterchangeLevel;
    Uint16          MaximumInterchangeLevel;
    Uint32          CharacterSetList;
    Uint32          MaximumCharacterSetList;
    dstring         VolumeSetIdentifier[128];
    struct charspec DescriptorCharacterSet;
    struct charspec ExplanatoryCharacterSet;
    struct extent_ad VolumeAbstract;
    struct extent_ad VolumeCopyrightNotice;
    struct EntityID ApplicationIdentifier;
    struct timestamp RecordingDateandTime;
    struct EntityID ImplementationIdentifier;
    byte            ImplementationUse[64];
    Uint32          PredecessorVolumeDescriptorSequenceLocation;
    Uint16          Flags;
    byte            Reserved[22];
}
```

2.2.2.1 Uint16 InterchangeLevel

- ☞ Interpreted as specifying the current interchange level (as specified in ECMA 167 3/11), of the contents of the associated volume and the restrictions implied by the specified level.
- ☞ If this volume is part of a multi-volume Volume Set then the level shall be set to 3, otherwise the level shall be set to 2.

ECMA 167 requires an implementation to enforce the restrictions associated with the specified current *Interchange Level*. The implementation may change the value of this field as long as it does not exceed the value of the *Maximum Interchange Level* field.

2.2.2.2 Uint16 MaximumInterchangeLevel

- ☞ Interpreted as specifying the maximum interchange level (as specified in ECMA 167 3/11), of the contents of the associated volume.
- ☞ This field shall be set to level 3 (No Restrictions Apply), unless specifically given a different value by the user.

NOTE: This field is used to determine the intent of the originator of the volume. If this field has been set to 2 then the originator does not wish the volume to be included in a multi-volume set (interchange level 3). The receiver may override this field and set it to a 3 but the implementation should give the receiver a strict warning explaining the intent of the originator of the volume.

2.2.2.3 Uint32 CharacterSetList

↪ Interpreted as specifying the character set(s) in use by any of the structures defined in Part 3 of ECMA 167 (3/10.1.9).

↪ Shall be set to indicate support for CS0 only as defined in 2.1.2.

2.2.2.4 Uint32 MaximumCharacterSetList

↪ Interpreted as specifying the maximum supported character sets (as specified in ECMA 167) which may be specified in the *CharacterSetList* field.

↪ Shall be set to indicate support for CS0 only as defined in 2.1.2.

2.2.2.5 dstring VolumeSetIdentifier

↪ Interpreted as specifying the identifier for the volume set .

↪ The first 16 characters of this field should be set to a unique value. The remainder of the field may be set to any allowed value. Specifically, software generating volumes conforming to this specification shall not set this field to a fixed or trivial value. Duplicate disks which are intended to be identical may contain the same value in this field.

NOTE: The intended purpose of this is to guarantee Volume Sets with unique identifiers. The first 8 characters of the unique part should come from a CS0 hexadecimal representation of a 32-bit time value. The remaining 8 characters are free for implementation use.

2.2.2.6 struct charspec DescriptorCharacterSet

↪ Interpreted as specifying the character sets allowed in the *Volume Identifier* and *Volume Set Identifier* fields.

↪ Shall be set to indicate support for CS0 as defined in 2.1.2.

2.2.2.7 struct charspec ExplanatoryCharacterSet

↪ Interpreted as specifying the character sets used to interpret the contents of the *VolumeAbstract* and *VolumeCopyrightNotice* extents.

✍ Shall be set to indicate support for CS0 as defined in 2.1.2.

2.2.2.8 struct EntityID ImplementationIdentifier;

For more information on the proper handling of this field see section 2.1.5.

2.2.3 Anchor Volume Descriptor Pointer

```
struct AnchorVolumeDescriptorPointer {          /* ECMA 167 3/10.2 */
    struct tag          DescriptorTag;
    struct extent_ad    MainVolumeDescriptorSequenceExtent;
    struct extent_ad    ReserveVolumeDescriptorSequenceExtent;
    byte                Reserved[480];
}
```

NOTE: An *AnchorVolumeDescriptorPointer* structure shall be recorded in at least 2 of the following 3 locations on the media :

- Logical Sector 256.
- Logical Sector (N - 256).
- N

NOTE: Unclosed CD-R media may have an *Anchor Volume Descriptor Pointer* recorded at only sector 512. Upon close, CD-R media will conform to the rules above.

2.2.3.1 struct MainVolumeDescriptorSequenceExtent

The main *VolumeDescriptorSequenceExtent* shall have a minimum length of 16 logical sectors.

2.2.3.2 struct ReserveVolumeDescriptorSequenceExtent

The reserve *VolumeDescriptorSequenceExtent* shall have a minimum length of 16 logical sectors.

2.2.4 Logical Volume Descriptor

```
struct LogicalVolumeDescriptor { /* ECMA 167 3/10.6 */
    struct tag      DescriptorTag;
    Uint32          VolumeDescriptorSequenceNumber;
    struct charspec DescriptorCharacterSet;
    dstring         LogicalVolumeIdentifier[128];
    Uint32          LogicalBlockSize,
    struct EntityID DomainIdentifier;
    byte           LogicalVolumeContentsUse[16];
    Uint32          MapTableLength;
    Uint32          NumberOfPartitionMaps;
    struct EntityID ImplementationIdentifier;
    byte           ImplementationUse[128];
    extent_ad      IntegritySequenceExtent,
    byte           PartitionMaps[];
}
```

2.2.4.1 struct charspec DescriptorCharacterSet

☞ Interpreted as specifying the character set allowed in the *LogicalVolumeIdentifier* field.

☞ Shall be set to indicate support for CS0 as defined in 2.1.2.

2.2.4.2 Uint32 LogicalBlockSize

☞ Interpreted as specifying the *Logical Block Size* for the logical volume identified by this *LogicalVolumeDescriptor*.

☞ This field shall be set to the largest logical sector size encountered amongst all the partitions on media that constitute the logical volume identified by this *LogicalVolumeDescriptor*. Since UDF requires that all Volumes within a VolumeSet have the same logical sector size, the *Logical Block Size* will be the same as the logical sector size of the Volume.

2.2.4.3 struct EntityID DomainIdentifier

☞ Interpreted as specifying a domain specifying rules on the use of, and restrictions on, certain fields in the descriptors. If this field is all zero then it is ignored, otherwise the *Entity Identifier* rules are followed. **NOTE:** If the field does not contain “*OSTA UDF Compliant” then an implementation may deny the user access to the logical volume.

☞ This field shall indicate that the contents of this logical volume conforms to the domain defined in this document, therefore the *DomainIdentifier* shall be set to:

“*OSTA UDF Compliant”

As described in the section on *Entity Identifier* the *IdentifierSuffix* field of this *EntityID* shall contain the revision of this document for which the contents of the Logical Volume is compatible. For more information on the proper handling of this field see section 2.1.5.

NOTE: The *IdentifierSuffix* field of this *EntityID* contains *SoftWriteProtect* and *HardWriteProtect* flags. Refer to 2.1.4.3.

2.2.4.4 byte LogicalVolumeContentUse[16]

This field contains the extent location of the FileSet Descriptor. This is described in 4/3.1 of ECMA 167 as follows:

“If the volume is recorded according to Part **Error! Reference source not found.**, the extent in which the first File Set Descriptor Sequence of the logical volume is recorded shall be identified by a long_ad (**Error! Reference source not found./Error! Reference source not found.**) recorded in the Logical Volume Contents Use field (see **Error! Reference source not found./Error! Reference source not found.**) of the Logical Volume Descriptor describing the logical volume in which the File Set Descriptors are recorded.”

This field can be used to find the FileSet descriptor, and from the FileSet descriptor the root volume can be found.

2.2.4.5 struct EntityID ImplementationIdentifier;

For more information on the proper handling of this field see the section on *Entity Identifier*.

2.2.4.6 struct extent_ad IntegritySequenceExtent

A value in this field is required for the Logical Volume Integrity Descriptor. For Rewriteable or Overwriteable media this shall be set to a minimum of 8K bytes.

WARNING: For *WORM* media this field should be set to an extent of some substantial length. Once the *WORM* volume on which the Logical Volume Integrity Descriptor resides is full a new volume must be added to the volume set since the Logical Volume Integrity Descriptor must reside on the same volume as the prevailing Logical Volume Descriptor.

2.2.4.7 byte PartitionMaps

For the purpose of interchange partition maps shall be limited to Partition Map type 1, except type 2 maps as described in this document (2.2.8 and 2.2.9).

2.2.5 Unallocated Space Descriptor

```
struct UnallocatedSpaceDesc { /* ECMA 167 3/10.8 */
    struct tag      DescriptorTag;
    Uint32          VolumeDescriptorSequenceNumber;
    Uint32          NumberOfAllocationDescriptors;
    extent_ad      AllocationDescriptors[];
}
```

This descriptor shall be recorded, even if there is no free volume space.

2.2.6 Logical Volume Integrity Descriptor

```
struct LogicalVolumeIntegrityDesc { /* ECMA 167 3/10.10 */
    struct tag      DescriptorTag,
    Timestamp      RecordingDateAndTime,
    Uint32          IntegrityType,
    struct extend_ad NextIntegrityExtent,
    byte           LogicalVolumeContentsUse[32],
    Uint32          NumberOfPartitions,
    Uint32          LengthOfImplementationUse,
    Uint32          FreeSpaceTable[],
    Uint32          SizeTable[],
    byte           ImplementationUse[]
}
```

The *Logical Volume Integrity Descriptor* is a structure that shall be written any time the contents of the associated Logical Volume is modified. Through the contents of the *Logical Volume Integrity Descriptor* an implementation can easily answer the following useful questions:

- 1) Are the contents of the Logical Volume in a consistent state?
- 2) When was the last date and time that anything within the Logical Volume was modified?
- 3) What is the total Logical Volume free space in logical blocks?
- 4) What is the total size of the Logical Volume in logical blocks?
- 5) What is the next available UniqueID for use within the Logical Volume?
- 6) Has some *other* implementation modified the contents of the logical volume since the last time that the *original* implementation which created the logical volume accessed it.

2.2.6.1 byte LogicalVolumeContentsUse

See the section on *Logical Volume Header Descriptor* for information on the contents of this field.

2.2.6.2 Uint32 FreeSpaceTable

Since most operating systems require that an implementation provide the true free space of a Logical Volume at mount time it is important that these values be maintained for all non-virtual partitions. The optional value of #FFFFFFFF, which indicates that the amount of available free space is not known, shall not be used for non-virtual partitions. For virtual partitions the FreeSpaceTable shall be set to #FFFFFFFF.

NOTE: The FreeSpaceTable is guaranteed to be correct only when the *Logical Volume Integrity Descriptor* is closed.

2.2.6.3 Uint32 SizeTable

Since most operating systems require that an implementation provide the total size of a Logical Volume at mount time it is important that these values be maintained for all non-virtual partitions. The optional value of #FFFFFFFF, which indicates that the partition size is not known, shall not be used for non-virtual partitions. For virtual partitions the SizeTable shall be set to #FFFFFFFF.

2.2.6.4 byte ImplementationUse

The *ImplementationUse* area for the *Logical Volume Integrity Descriptor* shall be structured as follows:

ImplementationUse format

RBP	Length	Name	Contents
0	32	ImplementationID	EntityID
32	4	Number of Files	Uint32
36	4	Number of Directories	Uint32
40	2	Minimum UDF Read Revision	Uint16
42	2	Minimum UDF Write Revision	Uint16
44	2	Maximum UDF Write Revision	Uint16
46	??	Implementation Use	byte

Implementation ID - The implementation identifier *EntityID* of the implementation which last modified anything within the scope of this *EntityID*. The scope of this *EntityID* is the Logical Volume Descriptor, and the contents of the associated Logical Volume. This field allows an implementation to identify which implementation last modified the contents of a Logical Volume.

Number of Files - The current number of files in the associated Logical Volume. This information is needed by the Macintosh OS. All

implementations shall maintain this information. NOTE: This value does not include Extended Attributes or streams as part of the file count.

Number of Directories - The current number of directories in the associated Logical Volume. This information is needed by the Macintosh OS. All implementations shall maintain this information.

NOTE: The root directory shall be included in the directory count. The directory count does not include stream directories.

Minimum UDF Read Revision - Shall indicate the minimum recommended revision of the UDF specification that an implementation is required to support to successfully be able to read all potential structures on the media. This number shall be stored in binary coded decimal format, for example #0150 would indicate revision 1.50 of the UDF specification.

Minimum UDF Write Revision - Shall indicate the minimum revision of the UDF specification that an implementation is required to support to successfully be able to modify all structures on the media. This number shall be stored in binary coded decimal format, for example #0150 would indicate revision 1.50 of the UDF specification.

Maximum UDF Write Revision - Shall indicate the maximum revision of the UDF specification that an implementation which has modified the media has supported. An implementation shall update this field only if it has modified the media and the level of the UDF specification it supports is higher than the current value of this field. This number shall be stored in binary coded decimal format, for example #0150 would indicate revision 1.50 of the UDF specification.

Implementation Use - Contains implementation specific information unique to the implementation identified by the Implementation ID.

2.2.7 Implementation Use Volume Descriptor

```
struct ImpUseVolumeDescriptor { /* ECMA 167 3/10.4 */
    struct tag      DescriptorTag;
    Uint32         VolumeDescriptorSequenceNumber;
    struct EntityID ImplementationIdentifier;
    byte           ImplementationUse[460];
}
```

This section defines an UDF Implementation Use Volume Descriptor. This descriptor shall be recorded on every Volume of a Volume Set. The Volume may also contain additional Implementation Use Volume Descriptors which are

implementation specific. The intended purpose of this descriptor is to aid in the identification of a Volume within a Volume Set that belongs to a specific Logical Volume.

NOTE: An implementation may still record an additional Implementation Use Volume Descriptor in its own format on the media. The UDF Implementation Use Volume Descriptor does not preclude an additional descriptor.

2.2.7.1 EntityID Implementation Identifier

This field shall specify “*UDF LV Info”.

2.2.7.2 bytes Implementation Use

The implementation use area shall contain the following structure:

```
struct LVInformation {
    struct charspec    LVICcharset,
    dstring            LogicalVolumeIdentifier[128],
    dstring            LVInfo1[36],
    dstring            LVInfo2[36],
    dstring            LVInfo3[36],
    struct EntityID    ImplementationID,
    bytes              ImplementationUse[128];
}
```

2.2.7.2.1 charspec LVICcharset

☞ Interpreted as specifying the character sets allowed in the *LogicalVolumeIdentifier* and *LVInfo* fields.

☞ Shall be set to indicate support for CS0 only as defined in 2.1.2.

2.2.7.2.2 dstring LogicalVolumeIdentifier

Identifies the Logical Volume referenced by this descriptor.

2.2.7.2.3 dstring LVInfo1

The fields LVInfo1, LVInfo2 and LVInfo3 should contain additional information to aid in the identification of the media. For example the LVInfo fields could contain information such as *Owner Name*, *Organization Name*, and *Contact Information*.

2.2.7.2.4 struct EntityID ImplementationID

Refer to the section on Entity Identifier.

2.2.7.2.5 bytes ImplementationUse[128]

This area may be used by the implementation to store any additional implementation specific information.

2.2.8 Virtual Partition Map

This is an extension of ECMA 167 to expand its scope to include sequentially written media (eg. CD-R). This extension is for a partition map entry to describe a virtual space.

The Logical Volume Descriptor contains a list of partitions that make up a given volume. As the virtual partition cannot be described in the same manner as a physical partition, a Type 2 partition map defined below shall be used.

If a Virtual Partition Map is recorded, then the Logical Volume Descriptor shall contain at least two partition maps. One partition map shall be recorded as a Type 1 partition map. One partition map shall be recorded as a Type 2 partition map. The format of this Type 2 partition map shall be as specified in the following table.

Layout of Type 2 partition map for virtual partition

RBP	Length	Name	Contents
0	1	Partition Map Type	Uint8 = 2
1	1	Partition Map Length	Uint8 = 64
2	2	Reserved	#00 bytes
4	32	Partition Type Identifier	EntityID
36	2	Volume Sequence Number	Uint16
38	2	Partition Number	Uint16
40	24	Reserved	#00 bytes

- Partition Type Identifier:
 - Flags = 0
 - Identifier = *UDF Virtual Partition
 - IdentifierSuffix is recorded as in section 2.1.5.3
- Volume Sequence Number = volume upon which the VAT and Partition is recorded
- Partition Number = an identification of a partition within the volume identified by the volume sequence number

2.2.9 Sparable Partition Map

Certain disk/drive systems do not perform defect management (eg. CD-RW). To provide an apparent defect-free space for these systems, a partition of type 2 is used. The partition map defines the partition number, packet size (see section 1.3.2), and size and locations of the sparing tables. This type 2 map is intended to replace the type 1 map normally found on the media. This map identifies not only the partition number and the volume sequence number, but also identifies the packet length and the sparing tables. A Sparable Partition Map shall not be recorded on disk/drive systems that perform defect management.

Layout of Type 2 partition map for sparable partition

RBP	Length	Name	Contents
0	1	Partition Map Type	Uint8 = 2
1	1	Partition Map Length	Uint8 = 64
2	2	Reserved	#00 bytes
4	32	Partition Type Identifier	EntityID
36	2	Volume Sequence Number	Uint16
38	2	Partition Number	Uint16
40	2	Packet Length	Uint16 = 32
42	1	Number of Sparing Tables (=N_ST)	Uint8
43	1	Reserved	#00 byte
44	4	Size of each sparing table	Uint32
48	4 * N_ST	Locations of sparing tables	Uint32
48 + 4 * N_ST	16 - 4 * N_ST	Pad	#00 bytes

- Partition Type Identifier:
 - Flags = 0
 - Identifier = *UDF Sparable Partition
 - IdentifierSuffix is recorded as in section 2.1.5.3.
- Partition Number = the number of this partition. Shall identify a Partition Descriptor associated with this partition.
- Packet Length = the number of user data blocks per fixed packet. Shall be set to 32.
- Number of Sparing Tables = the number of redundant tables recorded. This shall be a value in the range of 1 to 4.
- Size of each sparing table = Length, in bytes, allocated for each sparing table.
- Locations of sparing tables = the start locations of each sparing table specified as a media block address. Implementations should align the start of each sparing table with the beginning of a packet. Implementations should record at least two sparing tables in physically distant locations.

2.2.10 Virtual Allocation Table

The Virtual Allocation Table (VAT) is used on sequentially written media (eg. CD-R) to give the appearance of randomly writable media to the system. The existence of this partition is identified in the partition maps. The VAT shall only be recorded on sequentially written media (eg. CD-R).

The VAT is a map that translates Virtual Addresses to logical addresses. It shall be recorded as a file identified by a File Entry ICB (VAT ICB) which allows great flexibility in building the table. The VAT ICB is the last sector recorded in any transaction. The VAT itself may be recorded at any location.

The VAT shall be identified by a File Entry ICB with a file type of 248. This ICB shall be the last valid data sector recorded. Error recovery schemes can find the last valid VAT by finding ICBs with file type 248.

This file, when small, can be embedded in the ICB that describes it. If it is larger, it can be recorded in a sector or sectors preceding the ICB. The sectors do not have to be contiguous, which allows writing only new parts of the table if desired. This allows small incremental updates, even on disks with many directories.

When the VAT is small (a small number of directories on the disk), the VAT is updated by writing a new file ICB with the VAT embedded. When the VAT becomes too large to fit in the ICB, writing a single sector with the VAT and a second sector with the ICB is required. Beyond this point, more than one sector is required for the VAT. However, as multiple extents are supported, updating the VAT may consist of writing only the sector or sectors that need updating and writing the ICB with pointers to all of the pieces of the VAT.

The Virtual Allocation Table is used to redirect requests for certain information to the proper logical location. The indirection provided by this table provides the appearance of direct overwrite capability. For example, the ICB describing the root directory could be referenced as virtual sector 1. A virtual sector is contained in a partition identified by a virtual partition map entry. Over the course of updating the disk, the root directory may change. When it changes, a new sector describing the root directory is written, and its Logical Block Address is recorded as the Logical Block Address corresponding to virtual sector 1. Nothing that references virtual sector 1 needs to change, as it still points to the most current virtual sector 1 that exists, even though it exists at a new Logical Block Address.

The use of virtual addressing allows any desired structure to become effectively rewritable. The structure is rewritable when every pointer that references it does so only by its Virtual Address. When a replacement structure is written, the virtual reference does not need to change. The proper entry in the VAT is changed to reflect the new Logical Block Address of the corresponding Virtual Address and all virtual references then indirectly point to the new structure. All structures that require updating, such as directory ICBs, shall be referenced by a Virtual Address. As each structure is updated, its corresponding entry in the VAT ICB shall be updated.

The VAT shall be recorded as a sequence of Uint32 entries in a file. Each entry shall be the offset, in sectors, into the physical partition in which the VAT is located. The first entry shall be for the virtual partition sector 0, the second entry for virtual partition sector 1, etc. The Uint32 entries shall follow the VAT header. The entry for the previous VAT ICB allows for viewing the file system as it appeared in an earlier state. If this field is #FFFFFFFF, then no such ICB is specified.

Virtual Allocation Table structure

Offset	Length	Name	Contents
0	2	Length of Header (=L_HD)	Uint16
2	2	Length of Implementation Use (=L_IU)	Uint16
4	128	Logical Volume Identifier	dstring
132	4	Previous VAT ICB location	Uint32
136	4	Number of FIDs identifying Files	Uint32
140	4	Number of non-parent FIDs identifying Directories	Uint32
144	2	Min UDF Read version	Uint16
146	2	Min UDF Write version	Uint16
148	2	Max UDF Write version	Uint16
150	2	Reserved	#00 bytes
152	L_IU	Implementation Use	bytes
152 + L_IU	4	VAT entry 0	Uint32
156 + L_IU	4	VAT entry 1	Uint32
...
Information Length - 4	4	VAT entry n	Uint32

Length of Header - Indicates the amount of data preceding the VAT entries. This value shall be $152 + L_IU$.

Length of Implementation Use - Shall specify the number of bytes in the Implementation Use field. If this field is non-zero, the value shall be at least 32 and be an integral multiple of 4.

Logical Volume Identifier - Shall identify the logical volume. This field shall be used by implementations instead of the corresponding field in the Logical Volume Descriptor. The value of this field should be the same as the field in the LVD until changed by the user.

Previous VAT ICB Location - Shall specify the logical block number of an earlier VAT ICB in the partition identified by the partition map entry. If this field is #FFFFFFFF, no such ICB is specified.

Number of FIDs identifying Files - Identifies the number of files on the volume, including hard links. The number of files includes all FIDs in the heirarchy for which the directory bit is not set. The count does not include FIDs with the deleted bit set to one. The contents of this field shall be used by implementations instead of the corresponding field in the LVID.

Number of non-parent FIDs identifying Directories - Identifies the number of directories on the volume, plus the root directory. The count does not include FIDs with the deleted

bit set to one. The contents of this field shall be used by implementations instead of the corresponding field in the LVID.

Min UDF Read Version - Defined in 2.2.6. The contents of this field shall be used by implementations instead of the corresponding field in the Logical Volume Integrity Descriptor (LVID).

Min UDF Write Version - Defined in 2.2.6. The contents of this field shall be used by implementations instead of the corresponding field in the LVID.

Max UDF Write Version - Defined in 2.2.6. The contents of this field shall be used by implementations instead of the corresponding field in the LVID.

Implementation Use - If non-zero in length, shall begin with a Entity ID identifying the usage of the remainder of the Implementation Use area.

VAT Entry - VAT entry n shall identify the logical block number of the virtual block n . An entry of #FFFFFFFF indicates that the virtual sector is currently unused. The LBN specified is located in the partition identified by the partition map entry. The number of entries in the table can be determined from the VAT file size in the ICB:

$$\text{Number of entries (N)} = (\text{Information Length} - \text{L_HD}) / 4.$$

2.2.11 Sparing Table

Certain disk/drive systems do not perform defect management (eg. CD-RW). To provide an apparent defect-free space for these systems. Certain media can only be written in groups of sectors (“packets”), further complicating relocation: a whole packet must be relocated rather than only the sectors being written. To address this issue a sparing partition is identified in the partition map, which further identifies the location of the sparing tables. The sparing table identifies relocated areas on the media. Sparing tables are identified by a sparing partition map. Sparing tables shall not be recorded on disk/drive systems that perform defect management.

Sparing Tables point to space allocated for sparing and contains a list of mappings of defective sectors to their replacements. Separate copies of the sparing tables shall be recorded in separate packets. All instances of the sparing table shall be kept up to date.

Partitions map logical space to physical space. Normally, this is a linear mapping where an offset and a length is specified. A sparing partition is based on this mapping, where the offset and length of a partition within physical space is specified by a partition descriptor. The sparing table further specifies an exception list of logical to physical mappings. All mappings are one packet in length. The packet size is specified in the sparing partition map.

Available sparing areas may be anywhere on the media, either inside or outside of a partition. If located inside a partition, spareable space shall be marked as allocated and shall be included in the Non-Allocatable Space List. The mapped locations should be filled in at format time; the original locations are assigned dynamically as errors occur. Each sparing table shall be structured as shown below.

Sparing Table layout

BP	Length	Name	Contents
0	16	Descriptor Tag	tag = 0
16	32	Sparing Identifier	EntityID
48	2	Reallocation Table Length (=RT_L)	Uint16
50	2	Reserved	#00 bytes
52	4	Sequence Number	Uint32
56	8*RT_L	Map Entry	Map Entries

This structure may be larger than a single sector if necessary.

- Descriptor Tag
Contains a Tag Identifier of 0, which indicates that the format of the Descriptor Tag is not specified by ECMA 167. All other fields of the Descriptor Tag shall be valid, as if the Tag Identifier were one of the values defined by ECMA 167.
- Sparing Identifier:
 - Flags = 0
 - Identifier = *UDF Sparing Table
 - IdentifierSuffix is recorded as in UDF 2.1.5.3
- Reallocation Table Length
Indicates the number of entries in the Map Entry table.
- Sequence Number
Contains a number that shall be incremented each time the sparing table is updated.
- Map Entry
A map entry is described in the table below. Maps shall be sorted in ascending order by the Original Location field.

Map Entry description

RBP	Length	Name	Contents
0	4	Original Location	Uint32
4	4	Mapped Location	Uint32

- Original Location
Logical Block Address of the packet to be spared. The address of a packet is the address of the first user data block of a packet. If this field is #FFFFFFFF, then this entry is available for sparing. If this field is #FFFFFFF0, then the corresponding mapped location is marked as defective and should not be used for mapping. Original Locations of #FFFFFFF1 through #FFFFFFFE are reserved.

- **Mapped Location**
Physical Block Address of active data. Requests to the original packet location are redirected to the packet location identified here. All Mapped Location entries shall be valid, including those entries for which the Original Location is #FFFFFFF0, #FFFFFFF, or reserved. If the mapped location overlaps a partition, that partition shall have that space marked as allocated and that space shall be part of the Non-Allocatable Space list.

2.3 Part 4 - File System

2.3.1 Descriptor Tag

```
struct tag { /* ECMA 167 4/7.2 */
    Uint16 TagIdentifier;
    Uint16 DescriptorVersion;
    Uint8 TagChecksum;
    byte Reserved;
    Uint16 TagSerialNumber;
    Uint16 DescriptorCRC;
    Uint16 DescriptorCRCLength;
    Uint32 TagLocation;
}
```

2.3.1.1 Uint16 TagSerialNumber

⌘ Ignored.

✍ Reset to a unique value at volume initialization.

The *TagSerialNumber* shall be set to a value that differs from ones previously recorded, upon volume re-initialization. The intended use of this field is for disaster recovery. The *TagSerialNumber* for all descriptors in Part 4 should be the same as the serial number used in the associated File Set Descriptor

2.3.1.2 Uint16 DescriptorCRCLength

CRCs shall be supported and calculated for each descriptor, unless otherwise noted. The value of this field shall be set to: (Size of the Descriptor) - (Length of Descriptor Tag). When reading a descriptor the CRC should be validated.

2.3.2 File Set Descriptor

```
struct FileSetDescriptor { /* ECMA 167 4/14.1 */
    struct tag          DescriptorTag;
    struct timestamp    RecordingDateandTime;
    Uint16              InterchangeLevel;
    Uint16              MaximumInterchangeLevel;
    Uint32              CharacterSetList;
    Uint32              MaximumCharacterSetList;
    Uint32              FileSetNumber;
    Uint32              FileSetDescriptorNumber;
    struct charspec     LogicalVolumeIdentifierCharacterSet;
    dstring             LogicalVolumeIdentifier[128];
    struct charspec     FileSetCharacterSet;
    dstring             FileSetIdentifier[32];
    dstring             CopyrightFileIdentifier[32];
    dstring             AbstractFileIdentifier[32];
    struct long_ad      RootDirectoryICB;
    struct EntityID     DomainIdentifier;
    struct long_ad      NextExtent;
    struct long_ad      StreamDirectoryICB;
    byte               Reserved[32];
}
```

Only one *FileSet* descriptor shall be recorded. On WORM media, multiple *FileSets* may be recorded.

The UDF provision for multiple File Sets is as follows:

- Multiple *FileSets* are only allowed on WORM media.
- The default *FileSet* shall be the one with the highest *FileSetNumber*.
- Only the default *FileSet* may be flagged as writable. All other *FileSets* in the sequence shall be flagged *HardWriteProtect* (see EntityID definition).
- No writable *FileSet* shall reference any metadata structures which are referenced (directly or indirectly) by any other *FileSet*. Writable *FileSets* may, however, reference the actual file data extents.

Within a *FileSet* on WORM, if all files and directories have been recorded with ICB strategy type 4, then the *DomainID* of the corresponding *FileSet Descriptor* shall be marked as *HardWriteProtected*.

The intended purpose of multiple *FileSets* on WORM is to support the ability to have multiple archive images on the media. For example one *FileSet* could represent a backup of a certain set of information made at a specific point in time.

The next *FileSet* could represent another backup of the same set of information made at a later point in time.

2.3.2.1 Uint16 InterchangeLevel

- ☞ Interpreted as specifying the current interchange level (as specified in ECMA 167 4/15), of the contents of the associated file set and the restrictions implied by the specified level.
- ☞ Shall be set to a level of 3.

An implementation shall enforce the restrictions associated with the specified current *Interchange Level*.

2.3.2.2 Uint16 MaximumInterchangeLevel

- ☞ Interpreted as specifying the maximum interchange level of the contents of the associated file set. This value restricts to what the current *Interchange Level* field may be set.
- ☞ Shall be set to level 3.

2.3.2.3 Uint32 CharacterSetList

- ☞ Interpreted as specifying the character set(s) specified by any field, whose contents are specified to be a charspec, of any descriptor specified in Part 4 of ECMA 167 and recorded in the file set described by this descriptor.
- ☞ Shall be set to indicate support for CS0 only as defined in 2.1.2.

2.3.2.4 Uint32 MaximumCharacterSetList

- ☞ Interpreted as specifying the maximum supported character set in the associated file set and the restrictions implied by the specified level.
- ☞ Shall be set to indicate support for CS0 only as defined in 2.1.2.

2.3.2.5 struct charspec LogicalVolumeIdentifierCharacterSet

- ☞ Interpreted as specifying the d-characters allowed in the *Logical Volume Identifier* field.
- ☞ Shall be set to indicate support for CS0 as defined in 2.1.2.

2.3.2.6 struct charspec FileSetCharacterSet

- ☞ Interpreted as specifying the d-characters allowed in dstring fields defined in Part 4 of ECMA 167 that are within the scope of the FileSetDescriptor.
- ☞ Shall be set to indicate support for CS0 as defined in 2.1.2.

2.3.2.7 struct EntityID DomainIdentifier

- ☞ Interpreted as specifying a domain specifying rules on the use of, and restrictions on, certain fields in the descriptors. If this field is NULL then it is ignored, otherwise the *Entity Identifier* rules are followed.
- ☞ This field shall indicate that the scope of this *File Set Descriptor* conforms to the domain defined in this document, therefore the *ImplementationIdentifier* shall be set to:
"*OSTA UDF Compliant"

As described in the section on *Entity Identifier* the *IdentifierSuffix* field of this *EntityID* shall contain the revision of this document for which the contents of the Logical Volume is compatible. For more information on the proper handling of this field see the section on *Entity Identifier*.

NOTE: The *IdentifierSuffix* field of this *EntityID* contains *SoftWriteProtect* and *HardWriteProtect* flags.

2.3.3 Partition Header Descriptor

```
struct PartitionHeaderDescriptor {                               /* ECMA 167 4/14.3 */
    struct short_ad    UnallocatedSpaceTable;
    struct short_ad    UnallocatedSpaceBitmap;
    struct short_ad    PartitionIntegrityTable;
    struct short_ad    FreedSpaceTable;
    struct short_ad    FreedSpaceBitmap;
    byte               Reserved[88];
}
```

As a point of clarification the logical blocks represented as *Unallocated* are blocks that are ready to be written without any preprocessing. In the case of Rewritable media this would be a write without an erase pass. The logical blocks represented as *Freed* are blocks that are not ready to be written, and require some form of preprocessing. In the case of Rewritable media this would be a write with an erase pass.

NOTE: The use of Space Tables or Space Bitmaps shall be consistent across a Logical Volume. Space Tables and Space Bitmaps shall not both be used at the same time within a Logical Volume.

2.3.3.1 struct short_ad PartitionIntegrityTable

Shall be set to all zeros since *PartitionIntegrityEntry*s are not used.

2.3.4 File Identifier Descriptor

```
struct FileIdentifierDescriptor {                               /* ECMA 167 4/14.4 */
    struct tag        DescriptorTag;
    Uint16            FileVersionNumber;
    Uint8             FileCharacteristics;
    Uint8             LengthOfFileIdentifier;
    struct long_ad    ICB;
    Uint16            LengthOfImplementationUse;
    byte              ImplementationUse[];
    char              FileIdentifier[];
    byte              Padding[];
}
```

The *File Identifier Descriptor* shall be restricted to the length of one Logical Block.

2.3.4.1 Uint16 FileVersionNumber

 There shall be only one version of a file as specified below with the value being set to 1.

 Shall be set to 1.

2.3.4.2 File Characteristics

The deleted bit may be used to mark a file or directory as deleted instead of removing the FID from the directory, which requires rewriting the directory from that point to the end. If the space for the file or directory is deallocated, the implementation shall set the ICB field to zero, as all fields in a FID must be valid even if the deleted bit is set. See [4/14.4.3], note 21 and [4/14.4.5].

No two FIDs in a directory shall have the same File Identifier (and File Version Number, which shall be 1), regardless of the state of the deleted bits of those FIDs. See [4/8.6]. Note: Implementations should re-use FIDs with the deleted bit set to one and ICBs set to zero to avoid growing the size of the directory.

When deleting a File Identifier Descriptor an implementation may change the Compression ID to 0xFE and set the next four bytes, or to 0xFF and set the next eight bytes of the identifier to the byte offset of the FID within the directory as a Uint32 or Uint64 value. L_FI shall be set to 5 or 9. During scans of the directory, FIDs with a compression ID of 0xFE and 0xFF may be ignored.

2.3.4.3 struct long_ad ICB

The *Implementation Use* bytes of the long_ad in all *File Identifier Descriptors* shall be used to store the UDF Unique ID for the file and directory namespace.

UDF Unique ID

RBP	Length	Name	Contents
0	2	Reserved	bytes (= #00)
2	4	UDF Unique ID	Uint32

Section 3.2.1 Logical Volume Header Descriptor describes how *UDF Unique ID* field in Implementation Use bytes of the long_ad in the File Identifier Descriptor and the *UniqueID* field in the File Entry and Extended File Entry are set.

2.3.4.4 Uint16 LengthofImplementationUse

- ☞ Shall specify the length of the *ImplementationUse* field.
- ☞ Shall specify the length of the *ImplementationUse* field. This field may be ZERO, indicating that the *ImplementationUse* field has not been used.

When writing a File Identifier Descriptor to write-once media, to ensure that the Descriptor Tag field of the next FID will never span a block boundary, if there are less than 16 bytes remaining in the current block after the FID, the length of the FID shall be increased (using the Implementation Use field) enough to prevent this. The CRC length may be set to less than the size of the FID minus 16 (to not include the Implementation Use area).

2.3.4.5 byte ImplementationUse

- ☞ If the *LengthofImplementationUse* field is non ZERO then the first 32 bytes of this field shall be interpreted as specifying the implementation identifier *EntityID* of the implementation which last modified the *File Identifier Descriptor*.
- ☞ If the *LengthofImplementationUse* field is non ZERO then the first 32 bytes of this field shall be set to the implementation identifier *EntityID* of the current implementation.

NOTE: For additional information on the proper handling of this field refer to the section on *Entity Identifier*.

This field allows an implementation to identify which implementation last created and/or modified a specific *File Identifier Descriptor* .

2.3.5 ICB Tag

```
struct icbtag { /* ECMA 167 4/14.6 */
    Uint32    PriorRecordedNumberOfDirectEntries;
    Uint16    StrategyType;
    byte      StrategyParameter[2];
    Uint16    NumberOfEntries;
    byte      Reserved;
    Uint8     FileType;
    Lb_addr   ParentICBLocation;
    Uint16    Flags;
}
```

2.3.5.1 Uint16 StrategyType

- ☞ The contents of this field specifies the ICB strategy type used. For the purposes of read access an implementation shall support strategy types 4 and 4096.
- ☞ Shall be set to 4 or 4096.

NOTE: Strategy type 4096, which is defined in the appendix, is intended for primary use on WORM media, but may also be used on rewritable and overwritable media.

2.3.5.2 Uint8 FileType

As a point of clarification a value of 5 shall be used for a standard byte addressable file, *not 0*.

2.3.5.3 ParentICBLocation

The use of this field is optional.

NOTE: In ECMA 167-4/14.6.7 it states that “If this field contains 0, then no such ICB is specified.” This is a flaw in the ISO standard in that an implementation could store an ICB at logical block address 0. Therefore, if you decide to use this field, do not store an ICB at logical block address 0.

2.3.5.4 Uint16 Flags

Bits 0-2: These bits specify the type of allocation descriptors used. Refer to the section on *Allocation Descriptors* for the guidelines on choosing which type of allocation descriptor to use.

Bit 3 (*Sorted*):

☞ For OSTA UDF compliant media this bit shall indicate (ZERO) that directories may be unsorted.

☞ Shall be set to ZERO.

Bit 4 (*Non-relocatable*):

☞ For OSTA UDF compliant media this bit may indicate (ONE) that the file is non-relocatable. An implementation may reset this bit to ZERO to indicate that the file is relocatable if the implementation can not assure that the file will not be relocated.

☞ Should be set to ZERO.

Bit 9 (*Contiguous*):

☞ For OSTA UDF compliant media this bit may indicate (ONE) that the file is contiguous. An implementation may reset this bit to ZERO to indicate that the file may be non-contiguous if the implementation can not assure that the file is contiguous.

☞ Should be set to ZERO.

Bit 11 (*Transformed*):

☞ For OSTA UDF compliant media this bit shall indicate (ZERO) that no transformation has taken place.

☞ Shall be set to ZERO.

The methods used for data compression and other forms of data transformation might be addressed in a future OSTA document.

Bit 12 (*Multi-versions*):

☞ For OSTA UDF compliant media this bit shall indicate (ZERO) that multi-versioned files are not present.

☞ Shall be set to ZERO.

2.3.6 File Entry

```
struct FileEntry { /* ECMA 167 4/14.9 */
    struct tag      DescriptorTag;
    struct icbtag   ICBTag;
    Uint32          Uid;
    Uint32          Gid;
    Uint32          Permissions;
    Uint16          FileLinkCount;
    Uint8           RecordFormat;
    Uint8           RecordDisplayAttributes;
    Uint32          RecordLength;
    Uint64          InformationLength;
    Uint64          LogicalBlocksRecorded;
    struct timestamp AccessTime;
    struct timestamp ModificationTime;
    struct timestamp AttributeTime;
    Uint32          Checkpoint;
    struct long_ad  ExtendedAttributeICB;
    struct EntityID ImplementationIdentifier;
    Uint64          UniqueID,
    Uint32          LengthofExtendedAttributes;
    Uint32          LengthofAllocationDescriptors;
    byte            ExtendedAttributes[];
    byte            AllocationDescriptors[];
}
```

NOTE: The total length of a *FileEntry* shall not exceed the size of one logical block.

2.3.6.1 Uint8 RecordFormat;

☞ For OSTA UDF compliant media this bit shall indicate (ZERO) that the structure of the information recorded in the file is not specified by this field.

☞ Shall be set to ZERO.

2.3.6.2 Uint8 RecordDisplayAttributes;

☞ For OSTA UDF compliant media this bit shall indicate (ZERO) that the structure of the information recorded in the file is not specified by this field.

☞ Shall be set to ZERO.

2.3.6.3 Uint8 RecordLength;

☞ For OSTA UDF compliant media this bit shall indicate (ZERO) that the structure of the information recorded in the file is not specified by this field.

☞ Shall be set to ZERO.

2.3.6.4 Uint64 InformationLength

In most cases, the *InformationLength* can be reconstructed during a recovery operation by finding the sum of the lengths of each of the allocation descriptors. However, space may be allocated after the end of the file (identified as a “file tail.”) As allocated and unrecorded space is a legal part of a file, using the allocation descriptors to determine information length will fail if the next to last allocation descriptor for the file identifies 2^{30} - block size bytes, or if the next to last allocation descriptor is an integral multiple of the block size and the last allocation descriptor is not contiguous with the next to last allocation descriptor.

2.3.6.5 Uint64 LogicalBlocksRecorded

For files and directories with embedded data the value of this field shall be ZERO.

2.3.6.6 struct EntityID ImplementationIdentifier;

Refer to the section on *Entity Identifier*.

2.3.6.7 Uint64 UniqueID

For the *root* directory of a file set this value shall be set to ZERO.

Section 3.2.1 Logical Volume Header Descriptor describes how the UDF Unique ID field in the Implementation Use bytes of the long_ad in the File Identifier Descriptor and the UniqueID file in the File Entry and Extended File Entry are set.

2.3.7 Unallocated Space Entry

```
struct UnallocatedSpaceEntry {                               /* ECMA 167 4/14.11 */
    struct tag        DescriptorTag;
    struct icbtag     ICBTag;
    Uint32            LengthofAllocationDescriptors;
    byte              AllocationDescriptors[];
}
```

NOTE: The maximum length of an UnallocatedSpaceEntry shall be one Logical Block.

2.3.7.1 byte AllocationDescriptors

Only Short Allocation Descriptors shall be used.

NOTE: The upper 2 bits of the extent length field in allocation descriptors specify an extent type (ECMA 167 4/14.14.1.1). For the allocation descriptors specified for the UnallocatedSpaceEntry the type shall be set to a value of 1 to indicate *extent allocated but not recorded*, or shall be set to a value of 3 to indicate *the extent is the next extent of allocation descriptors*. This next extent of allocation descriptors shall be limited to the length of one Logical Block.

AllocationDescriptors shall be ordered sequentially in ascending location order. No overlapping *AllocationDescriptors* shall exist in the table. For example, ad.location = 2, ad.length = 2048 (logical block size = 1024) then nextad.location = 3 is not allowed. Adjacent *AllocationDescriptors* shall not be contiguous. For example ad.location = 2, ad.length = 1024 (logical block size = 1024), nextad.location = 3 is not allowed and would instead be a single *AllocationDescriptor*, ad.location = 2, ad.length = 2048. The only case where adjacent *AllocationDescriptors* may be contiguous is when the ad.length of one of the adjacent *AllocationDescriptors* is equal to the maximum *AllocationDescriptors* length.

2.3.8 Space Bitmap Descriptor

```
struct SpaceBitmap { /* ECMA 167 4/14.11 */
    struct Tag      DescriptorTag;
    Uint32          NumberOfBits;
    Uint32          NumberOfBytes;
    byte            Bitmap[];
}
```

2.3.8.1 struct Tag DescriptorTag

The calculation and maintenance of the *DescriptorCRC* field of the Descriptor Tag for the *SpaceBitmap* descriptor is optional. If the CRC is not maintained then both the *DescriptorCRC* and *DescriptorCRCLength* fields shall be ZERO.

2.3.9 Partition Integrity Entry

```
struct PartitionIntegrityEntry { /* ECMA 167 4/14.13 */
    struct tag      DescriptorTag;
    struct icbtag   ICBTag;
    struct timestamp RecordingTime;
    Uint8          IntegrityType;
    byte           Reserved[175];
    struct EntityID ImplementationIdentifier;
    byte           ImplementationUse[256];
}
```

With the functionality of the *Logical Volume Integrity Descriptor* this descriptor is not needed, therefore this descriptor shall not be recorded.

2.3.10 Allocation Descriptors

When constructing the data area of a file an implementation has several types of allocation descriptors from which to choose. The following guidelines shall be followed in choosing the proper allocation descriptor to be used:

Short Allocation Descriptor - For a Logical Volume that resides on a single Volume with no intent to expand the Logical Volume beyond the single volume *Short Allocation Descriptors* should be used. For example a Logical Volume created for a stand alone drive.

NOTE: Refer to section 2.2.2.2 on the *MaximumInterchangeLevel*.

Long Allocation Descriptor - For a Logical Volume that resides on a single Logical Volume with intent to later expand the Logical Volume beyond the single volume, or a Logical Volume that resides on multiple Volumes *Long Allocation Descriptors* should be used. For example a Logical Volume created for a jukebox.

NOTE: There is a benefit of using Long Allocation Descriptors even on a single volume, which is the support of tracking erased extents on rewritable media. See section 2.3.10.1 for additional information.

For both Short and Long Allocation Descriptors, if the 30 least significant bits of the *ExtentLength* field is 0, then the 2 most significant bits shall be 0.

Allocation Descriptors identifying virtual space shall have an extent length of the block size or less. Allocation descriptors identifying file data, directories, or stream data shall identify physical space. ICBs recorded in virtual space shall use *long_ad* allocation descriptors to identify physical space. The use of *short_ad* allocation descriptors would identify file data in virtual space if the ICB were in virtual space.

Descriptors recorded in virtual space shall have the virtual logical block number recorded in the Tag Location field.

2.3.10.1 Long Allocation Descriptor

```
struct long_ad {          /* ECMA 167 4/14.14.2 */
    Uint32      ExtentLength;
    Lb_addr     ExtentLocation;
    byte        ImplementationUse[6];
}
```

To allow use of the *ImplementationUse* field by UDF and also by implementations the following structure shall be recorded within the 6 byte *Implementation Use* field.

```
struct ADImpUse
{
    Uint16 flags;
    byte  impUse[4];
}

/*
 * ADImpUse Flags (NOTE: bits 1-15 reserved for future use by
 * UDF)
 */
#define EXTENTERased      (0x01)
```

In the interests of efficiency on *Rewritable* media that benefits from preprocessing, the EXTENTERased flag shall be set to ONE to indicate an *erased* extent. This applies only to extents of type *not recorded but allocated*.

2.3.11 Allocation Extent Descriptor

```
struct AllocationExtentDescriptor { /* ECMA 167 4/14.5 */
    struct tag      DescriptorTag;
    Uint32          PreviousAllocationExtentLocation;
    Uint32          LengthOfAllocationDescriptors;
}
```

NOTE: *AllocationDescriptor* extents shall be a maximum of one logical block in length.

2.3.11.1 Uint12 PreviousAllocationExtentLocation

- ☞ The previous allocation extent location shall not be used.
- ☞ Shall be set to 0.

2.3.12 Pathname

2.3.12.1 Path Component

```
struct PathComponent { /* ECMA 167 4/14.16.1 */
    Uint8      ComponentType;
    Uint8      LengthofComponentIdentifier;
    Uint16     ComponentFileVersionNumber;
    char       ComponentIdentifier[ ];
}
```

2.3.12.1.1 Uint16 ComponentFileVersionNumber

- ☞ There shall be only one version of a file as specified below with the value being set to ZERO.
- ☞ Shall be set to ZERO.

2.4 Part 5 - Record Structure

Record structure files shall not be created. If they are encountered on the media and they are not supported by the implementation they shall be treated as an uninterpreted stream of bytes.

3. System Dependent Requirements

3.1 Part 1 - General

3.1.1 Timestamp

```
struct timestamp {          /* ECMA 167 1/7.3 */
    Uint16                 TypeAndTimezone;
    Uint16                 Year;
    Uint8                  Month;
    Uint8                  Day;
    Uint8                  Hour;
    Uint8                  Minute;
    Uint8                  Second;
    Uint8                  Centiseconds;
    Uint8                  HundredsofMicroseconds;
    Uint8                  Microseconds;
}
```

3.1.1.1 Uint8 **Centiseconds;**

☞ For operating systems that do not support the concept of *centiseconds* the implementation shall ignore this field.

☞ For operating systems that do not support the concept of *centiseconds* the implementation shall set this field to ZERO.

3.1.1.2 Uint8 **HundredsofMicroseconds;**

☞ For operating systems that do not support the concept of *hundreds of Microseconds* the implementation shall ignore this field.

☞ For operating systems that do not support the concept of a *hundreds of Microseconds* the implementation shall set this field to ZERO.

3.1.1.3 Uint8 **Microseconds;**

☞ For operating systems that do not support the concept of *microseconds* the implementation shall ignore this field.

☞ For operating systems that do not support the concept of *microseconds* the implementation shall set this field to ZERO.

3.2 Part 3 - Volume Structure

3.2.1 Logical Volume Header Descriptor

```
struct LogicalVolumeHeaderDesc {                               /* ECMA 167 4/14.15 */
    Uint64                UniqueID,
    bytes                 reserved[24]
}
```

3.2.1.1 Uint64 UniqueID

This field contains the next *UniqueID* value which should be used. The field is initialized to 16, and it monotonically increases with each assignment described below. Whenever the lower 32-bits of this value reach #FFFFFFFF, the upper 32-bits are incremented by 1, as would be expected for a 64-bit value, but the lower 32-bits “wrap” to 16 (the initialization value). This behavior supports Mac™ OS which uses an ID number space of 16 through $2^{32} - 1$ inclusive, and will not cause problems for other platforms.

UniqueID is used whenever a new file or directory is created, or another name is linked to an existing file or directory. The File Identifier Descriptors and File Entries/Extended File Entries used for a stream directory and named streams associated with a file or directory do not use UniqueID; rather, the unique ID fields in these structures take their value from the UniqueID of the File Entry/Extended File Entry of the file/directory the streams are associated with.

When a file or directory is created, this UniqueID is assigned to the UniqueID field of the File Entry/Extended File Entry, the lower 32-bits of UniqueID are assigned to UDFUniqueID in the Implementation Use bytes of the long_ad in the File Identifier Descriptor (see 2.3.4.2), and UniqueID is incremented by the policy described above.

When a name is linked to an existing file or directory, the lower 32-bits of NextUniqueID are assigned to UDFUniqueID in the Implementation Use bytes of the long_ad in the File Identifier Descriptor (see 2.3.4.2), and UniqueID is incremented by the policy described above.

The lower 32-bits shall be the same in the File Entry/Extended File Entry and its first File Identifier Descriptor, but they shall differ in subsequent FIDs.

All UDF implementations shall maintain the UDFUniqueID in the FID and UniqueID in the FE/EFE as described in this section. The LVHD in a closed Logical Volume Integrity Descriptor shall have a valid UniqueID.

3.3 Part 4 - File System

3.3.1 File Identifier Descriptor

```
struct FileIdentifierDescriptor {                               /* ECMA 167 4/14.4 */
    struct tag          DescriptorTag;
    Uint16              FileVersionNumber;
    Uint8               FileCharacteristics;
    Uint8               LengthOfFileIdentifier;
    struct long_ad      ICB;
    Uint16              LengthofImplementationUse;
    byte                ImplementationUse[];
    char                FileIdentifier[];
    byte                Padding[];
}
```

NOTE: All UDF directories shall include a File Identifier Descriptor that indicates the location of the parent directory. The File Identifier Descriptor describing the parent directory shall be the first File Identifier Descriptor recorded in the directory. The parent directory of the Root directory shall be Root, as stated in ECMA 167-4, section 8.6

3.3.1.1 Uint8 FileCharacteristics

The following sections describe the usage of the *FileCharacteristics* under various operating systems.

3.3.1.1.1 MS-DOS, OS/2, Windows 95, Windows NT, Macintosh

☞ If Bit 0 is set to ONE, the file shall be considered a "hidden" file.
If Bit 1 is set to ONE, the file shall be considered a "directory."
If Bit 2 is set to ONE, the file shall be considered "deleted."
If Bit 3 is set to ONE, the ICB field within the associated *FileIdentifier* structure shall be considered as identifying the "parent" directory of the directory that this descriptor is recorded in

☞ If the file is designated as a "hidden" file, Bit 0 shall be set to ONE.
If the file is designated as a "directory," Bit 1 shall be set to ONE.
If the file is designated as "deleted," Bit 2 shall be set to ONE.

3.3.1.1.2 UNIX

Under UNIX these bits shall be processed the same as specified in 3.3.1.1.1., except for hidden files which will be processed as normal non-hidden files.

3.3.2 ICB Tag

```
struct icbtag { /* ECMA 167 4/14.6 */
    Uint32    PriorRecordedNumberOfDirectEntries;
    Uint16    StrategyType;
    byte      StrategyParameter[2];
    Uint16    NumberOfEntries;
    byte      Reserved;
    Uint8     FileType;
    Lb_addr   ParentICBLocation;
    Uint16    Flags;
}
```

3.3.2.1 Uint16 Flags

3.3.2.1.1 MS-DOS, OS/2, Windows 95, Windows NT

Bits 6 & 7 (*Setuid & Setgid*):

☞ Ignored.

☞ In the interests of maintaining security under environments which do support these bits; bits 6 and 7 shall be set to ZERO if any one of the following conditions are true :

- A file is created.
- The attributes/permissions associated with a file, are modified .
- A file is *written to* (the contents of the data associated with a file are modified).
- An Extended Attribute associated with the file is modified.
- A stream associated with a file is modified.

Bit 8 (*Sticky*):

☞ Ignored.

☞ Shall be set to ZERO.

Bit 10 (*System*):

☞ Mapped to the MS-DOS / OS/2 system bit.

☞ Mapped from the MS-DOS / OS/2 system bit.

3.3.2.1.2 Macintosh

Bits 6 & 7 (*Setuid & Setgid*):

☞ Ignored.

☞ In the interests of maintaining security under environments which do support these bits; bits 6 and 7 shall be set to ZERO if any one of the following conditions are true :

- A file is created.
- The attributes/permissions associated with a file, are modified .
- A file is *written to* (the contents of the data associated with a file are modified).
- An Extended Attribute associated with the file is modified.
- A stream associated with a file is modified.

Bit 8 (*Sticky*):

☞ Ignored.

☞ Shall be set to ZERO.

Bit 10 (*System*):

☞ Ignored.

☞ Shall be set to ZERO.

3.3.2.1.3 UNIX

Bits 6, 7 & 8 (*Setuid, Setgid, Sticky*):

These bits are mapped to/from the corresponding standard UNIX file system bits.

Bit 10 (*System*):

☞ Ignored.

☞ Shall be set to ZERO upon file creation only, otherwise maintained.

3.3.3 File Entry

```
struct FileEntry { /* ECMA 167 4/14.9 */
    struct tag      DescriptorTag;
    struct icbtag   ICBTag;
    Uint32          Uid;
    Uint32          Gid;
    Uint32          Permissions;
    Uint16          FileLinkCount;
    Uint8           RecordFormat;
    Uint8           RecordDisplayAttributes;
    Uint32          RecordLength;
    Uint64          InformationLength;
    Uint64          LogicalBlocksRecorded;
    struct timestamp AccessTime;
    struct timestamp ModificationTime;
    struct timestamp AttributeTime;
    Uint32          Checkpoint;
    struct long_ad  ExtendedAttributeICB;
    struct EntityID ImplementationIdentifier;
    Uint64          UniqueID,
    Uint32          LengthofExtendedAttributes;
    Uint32          LengthofAllocationDescriptors;
    byte            ExtendedAttributes[];
    byte            AllocationDescriptors[];
}
```

NOTE: The total length of a *FileEntry* shall not exceed the size of one logical block.

3.3.3.1 Uint32 Uid

- ☞ For operating systems that do not support the concept of a *user identifier* the implementation shall ignore this field. For operating systems that do support this field a value of $2^{32} - 1$ shall indicate an invalid UID, otherwise the field contains a valid *user identifier*.
- ☞ For operating systems that do not support the concept of a *user identifier* the implementation shall set this field to $2^{32} - 1$ to indicate an invalid UID, unless otherwise specified by the user.

3.3.3.2 Uint32 Gid

- ☞ For operating systems that do not support the concept of a *group identifier* the implementation shall ignore this field. For operating systems that do support this field a value of $2^{32} - 1$ shall indicate an invalid GID, otherwise the field contains a valid *group identifier*.

- ✍ For operating systems that do not support the concept of a *group identifier* the implementation shall set this field to $2^{32} - 1$ to indicate an invalid GID, unless otherwise specified by the user.

3.3.3.3 Uint32 Permissions;

```

/* Definitions: */
/* Bit      for a File      for a Directory      */
/* ----- ----- */
/* Execute May execute file      May search directory      */
/* Write   May change file contents May create and delete files */
/* Read    May examine file contents May list files in directory */
/* ChAttr  May change file attributes May change dir attributes */
/* Delete  May delete file        May delete directory      */

#define OTHER_Execute 0x00000001
#define OTHER_Write   0x00000002
#define OTHER_Read    0x00000004
#define OTHER_ChAttr  0x00000008
#define OTHER_Delete  0x00000010

#define GROUP_Execute 0x00000020
#define GROUP_Write   0x00000040
#define GROUP_Read    0x00000080
#define GROUP_ChAttr  0x00000100
#define GROUP_Delete  0x00000200

#define OWNER_Execute 0x00000400
#define OWNER_Write   0x00000800
#define OWNER_Read    0x00001000
#define OWNER_ChAttr  0x00002000
#define OWNER_Delete  0x00004000

```

The concept of permissions which deals with security is not completely portable between operating systems. This document attempts to maintain consistency among implementations in processing the permission bits by addressing the following basic issues:

1. How should an implementation handle Owner, Group and Other permissions when the operating system has no concept of User and Group Ids?
2. How should an implementation process permission bits when encountered, specifically permission bits that do not directly map to an operating system supported permission bit?
3. What default values should be used for permission bits that do not directly map to an operating system supported permission bit when creating a new file?

User, Group and Other

In general, for operating systems that do not support User and Group Ids the following algorithm should be used when processing permission bits:

When reading a specific permission, the logical OR of all three (owner, group, other) permissions should be the value checked. For example a file would be considered writable if the logical OR of OWNER_Write, GROUP_Write and OTHER_Write was equal to one.

When setting a specific permission the implementation should set all three (owner, group, other) sets of permission bits. For example to mark a file as writable the OWNER_Write, GROUP_Write and OTHER_Write should all be set to one.

Default Permission Values

For the operating systems covered by this document the following table describes what default values should be used for permission bits that do not directly map to an operating system supported permission bit when creating a new file.

Permission	File/Directory	Description	DOS	OS/2	Win 95	Win NT	Mac OS	UNIX
Read	file	The file may be read	1	1	1	1	1	U
Read	directory	The directory may be read, only if the directory is also marked as <i>Execute</i> .	1	1	1	1	1	U
Write	file	The file's contents may be modified	U	U	U	U	U	U
Write	directory	Files or subdirectories may be renamed, added, or deleted, only if the directory is also marked as <i>Execute</i> .	U	U	U	U	U	U
Execute	file	The file may be executed.	0	0	0	0	0	U
Execute	directory	The directory may be searched for a specific file or subdirectory.	1	1	1	1	1	U
Attribute	file	The file's permissions may be changed.	1	1	1	1	1	Note 1
Attribute	directory	The directory's permissions may be changed.	1	1	1	1	1	Note 1
Delete	file	The file may be deleted.	Note 2	Note 2	Note 2	Note 2	Note 2	Note 2
Delete	directory	The directory may be deleted.	Note 2	Note 2	Note 2	Note 2	Note 2	Note 2

U - User Specified, 1 - Set, 0 - Clear

NOTE 1: Under UNIX only the owner of a file/directory may change its attributes.

NOTE 2: The Delete permission bit should be set based upon the status of the *Write* permission bit. Under DOS, OS/2 and Macintosh, if a file or directory is marked as writable (*Write* permission set) then the file is considered deletable and the *Delete* permission bit should be set. If a file is read only then the *Delete* permission bit should not be set. This applies to file create as well as changing attributes of a file.

Processing Permissions

Implementation shall process the permission bits according to the following table which describes how to process the permission bits under the operating systems covered by this document. The table addresses the issues associated with permission bits that do not directly map to an operating system supported permission bit.

Permission	File/Directory	Description	DOS	OS/2	Win 95	Win NT	Mac OS	UNIX
Read	file	The file may be read	E	E	E	E	E	E
Read	directory	The directory may be read	E	E	E	E	I	E
Write	file	The file's contents may be modified	E	E	E	E	E	E
Write	directory	Files or subdirectories may be created, deleted or renamed	E	E	E	E	E	E
Execute	file	The file may be executed.	I	I	I	I	I	E
Execute	directory	The directory may be searched for a specific file or subdirectory.	E	E	E	E	E	E
Attribute	file	The file's permissions may be changed.	E	E	E	E	E	E

Attribute	directory	The directory's permissions may be changed.	E	E	E	E	E	E
Delete	file	The file may be deleted.	E	E	E	E	E	E
Delete	directory	The directory may be deleted.	E	E	E	E	E	E

E - Enforce, I - Ignore

The *Execute* bit for a directory, sometimes referred to as the *search* bit, has special meaning. This bit enables a directory to be searched, but not have its contents listed. For example assume a directory called PRIVATE exists which only has the *Execute* permission and does not have the *Read* permission bit set. The contents of the directory PRIVATE can not be listed. Assume there is a file within the PRIVATE directory called README. The user can get access to the README file since the PRIVATE directory is searchable.

To be able to list the contents of a directory both the *Read* and *Execute* permission bits must be set for the directory. To be able to create, delete and rename a file or subdirectory both the *Write* and *Execute* permission bits must be set for the directory. To get a better understanding of the *Execute* bit for a directory reference any UNIX book that covers file and directory permissions. The rules defined by the *Execute* bit for a directory shall be enforced by all implementations. The exception to this rule applies to Macintosh implementations. A Macintosh implementation may ignore the status of the *Read* bit in determining the accessibility of a directory

NOTE: To be able to delete a file or subdirectory the *Delete* permission bit for the file or subdirectory must be set, and both the *Write* and *Execute* permission bits must be set for the directory it occupies.

3.3.3.4 Uint64 UniqueID

NOTE: For some operating systems (i.e. Macintosh) this value needs to be less than the max value of a *Int32* ($2^{31} - 1$). Under the Macintosh operating system this value is used to represent the Macintosh directory/file ID. Therefore an implementation should attempt to keep this value less than the max value of a *Int32* ($2^{31} - 1$). The values 1-15 shall be reserved for the use of Macintosh implementations.

3.3.3.5 byte Extended Attributes

Certain extended attributes should be recorded in this field of the *FileEntry* for performance reasons. Other extended attributes should be recorded in an ICB pointed to by the field *ExtendedAttributeICB*. In the section on *Extended Attributes* it will be specified which extended attributes should be recorded in this field.

3.3.4 Extended Attributes

In order to handle some of the longer Extended Attributes (EAs) which may vary in length, the following rules apply to the EA space.

1. All EAs with an attribute length greater than or equal to a logical block shall be block aligned by starting and ending on a logical block boundary.

2. Smaller EAs shall be constrained to an attribute length which is a multiple of 4 bytes.
3. Each Extended Attribute space shall appear as a single contiguous logical space constructed as follows:

ECMA 167 EAs
Non block aligned Implementation Use EAs
Block aligned Implementation Use EAs
Application Use EAs

NOTE: There may exist 2 Extended Attribute spaces per file, one embedded in the *File Entry* or *Extended File Entry* and the other as a separate space referenced by the Extended Attribute ICB address in the *File Entry* or *Extended File Entry*. Each Extended Attribute space, if present, must have its own Extended Attribute Header Descriptor (see the next section).

3.3.4.1 Extended Attribute Header Descriptor

```
struct ExtendedAttributeHeaderDescriptor { /* ECMA 167 4/14.10.1 */
    struct tag      DescriptorTag;
    UInt32          ImplementationAttributesLocation;
    UInt32          ApplicationAttributesLocation;
}
```

⌘ A value in one of the *location* fields highlighted above equal to or greater than the length of the EA space shall be interpreted as an indication that the corresponding attribute does not exist.

✍ If an attribute associated with one of the *location* fields highlighted above does not exist, then the value of the corresponding *location* field shall be set to #FFFFFFFF."

3.3.4.2 Alternate Permissions

```
struct AlternatePermissionsExtendedAttribute { /* ECMA 167 4/14.10.4 */
    UInt32      AttributeType;
    UInt8      AttributeSubtype;
    byte       Reserved[3];
    UInt32     AttributeLength;
    UInt16     OwnerIdentification;
    UInt16     GroupIdentification;
    UInt16     Permission;
}
```

This structure shall not be recorded.

3.3.4.3 File Times Extended Attribute

```
struct FileTimesExtendedAttribute { /* ECMA 167 4/14.10.5 */
    Uint32      AttributeType;
    Uint8       AttributeSubtype;
    byte        Reserved[3];
    Uint32      AttributeLength;
    Uint32      DataLength;
    Uint32      FileTimeExistence;
    byte        FileTimes;
}
```

3.3.4.3.1 byte FileTimes

- ☞ If this field contains a file creation time it shall be interpreted as the creation time of the associated file. If the main *File Entry* is an *Extended File Entry*, the file creation time in this structure shall be ignored and the file creation time from the main *File Entry* shall be used.
- ☞ If the main File Entry is an Extended File Entry, this structure shall not be recorded with a file creation time.

If the main *File Entry* is not an *Extended File Entry* and the File Times Extended Attribute does not exist or does not contain the file creation time then an implementation shall use the *Modification Time* field of the *File Entry* to represent the file creation time.

3.3.4.4 Device Specification Extended Attribute

```
struct DeviceSpecificationExtendedAttribute { /* ECMA 167 4/14.10.7 */
    Uint32      AttributeType;
    Uint8       AttributeSubtype;
    byte        Reserved[3];
    Uint32      AttributeLength;
    Uint32      ImplementationUseLength; /* (=IU_L) */
    Uint32      MajorDeviceIdentification;
    Uint32      MinorDeviceIdentification;
    byte        ImplementationUse[IU_L];
}
```

The following paradigm shall be followed by an implementation that creates a *Device Specification Extended Attribute* associated with a file :

If and only if a file has a *DeviceSpecificationExtendedAttribute* associated with it, the contents of the *FileType* field in the *icbtag* structure be set to 6

(indicating a block special device file), OR 7 (indicating a character special device file).

If the contents of the *FileType* field in the *icbtag* structure do not equal 6 or 7, the *DeviceSpecificationExtendedAttribute* associated with a file shall be ignored.

In the event that the contents of the *FileType* field in the *icbtag* structure equal 6 or 7, and the file does not have a *DeviceSpecificationExtendedAttribute* associated with it, access to the file shall be denied.

For operating system environments that do not provide for the semantics associated with a block special device file, requests to open/read/write/close a file that has the *DeviceSpecificationExtendedAttribute* associated with it shall be denied.

All implementations shall record a developer ID in the *ImplementationUse* field that uniquely identifies the current implementation.

3.3.4.5 Implementation Use Extended Attribute

```
struct ImplementationUseExtendedAttribute { /* ECMA 167 4/14.10.8 */
    Uint32      AttributeType;
    Uint8       AttributeSubtype;
    byte        Reserved[3];
    Uint32      AttributeLength;
    Uint32      ImplementationUseLength; /* (=IU_L) */
    struct EntityID ImplementationIdentifier;
    byte        ImplementationUse[IU_L];
}
```

The *AttributeLength* field specifies the length of the entire extended attribute. For variable length extended attributes defined using the *Implementation Use Extended Attribute* the *Attribute Length* field should be large enough to leave padding space between the end of the *Implementation Use* field and the end of the *Implementation Use Extended Attribute*.

The following sections describe how the *Implementation Use Extended Attribute* is used under various operating systems to store operating system specific extended attributes.

The structures defined in the following sections contain a *header checksum* field. This field represents a 16-bit checksum of the Implementation Use Extended Attribute header. The fields *AttributeType* through *ImplementationIdentifier* inclusively represent the data covered by the *checksum*. The *header checksum*

field is used to aid in disaster recovery of the extended attribute space. C source code for the header checksum may be found in the appendix.

NOTE: All compliant implementations shall preserve existing extended attributes encountered on the media. Implementations shall create and support the extended attributes for the operating system they currently support. For example, a Macintosh implementation shall preserve any OS/2 extended attributes encountered on the media. It shall also create and support all Macintosh extended attributes specified in this document.

3.3.4.5.1 All Operating Systems

3.3.4.5.1.1 FreeEASpace

This extended attribute shall be used to indicate unused space within the extended attribute space. This extended attributes shall be stored as an *Implementation Use Extended Attribute* whose *ImplementationIdentifier* shall be set to:

"*UDF FreeEASpace"

The *ImplementationUse* area for this extended attribute shall be structured as follows:

FreeEASpace format

RBP	Length	Name	Contents
0	2	Header Checksum	Uint16
2	IU_L-1	Free EA Space	bytes

This extended attribute allows an implementation to shrink/grow the total size of other extended attributes without rewriting the complete extended attribute space. The *FreeEASpace* extended attribute may be overwritten and the space re-used by any implementation who sees a need to overwrite it.

3.3.4.5.1.2 DVD Copyright Management Information

This extended attribute shall be used to store DVD Copyright Management Information. This extended attribute shall be stored as an *Implementation Use Extended Attribute* whose *ImplementationIdentifier* shall be set to:

"*UDF DVD CGMS Info"

The *ImplementationUse* area for this extended attribute shall be structured as follows:

DVD CGMS Info format

RBP	Length	Name	Contents
0	2	Header Checksum	Uint16
2	1	CGMS Information	byte
3	1	Data Structure Type	Uint8
4	4	Protection System Information	bytes

This extended attribute allows DVD Copyright Management Information to be stored. The interpretation of this format shall be defined in the DVD specification published by the DVD Consortium (see 6.9.3). Support for this extended attribute is optional.

3.3.4.5.2 MS-DOS, Windows 95, Windows NT

☞ Ignored.

☞ Not supported. Extended attributes for existing files on the media shall be preserved.

3.3.4.5.3 OS/2

OS/2 supports an unlimited number of extended attributes which shall be stored as a named stream as defined in 3.3.8.2. To enhance performance the following *Implementation Use Extended Attribute* will be created.

3.3.4.5.3.1 OS2EALength

This attribute specifies the OS/2 Extended Attribute Stream (3.3.8.2) information length. Since this value needs to be reported back to OS/2 under certain directory operations, for performance reasons it *should* be recorded in the *ExtendedAttributes* field of the *FileEntry*. This extended attribute shall be stored as an *Implementation Use Extended Attribute* whose *ImplementationIdentifier* shall be set to:

"*UDF OS/2 EALength"

The *ImplementationUse* area for this extended attribute shall be structured as follows:

OS2EALength format

RBP	Length	Name	Contents
0	2	Header Checksum	Uint16
2	4	OS/2 Extended Attribute Length	Uint32

The value recorded in the *OS2ExtendedAttributeLength* field shall be equal to the *InformationLength* field of the file entry for the *OS2EA* stream.

3.3.4.5.4 Macintosh OS

The Macintosh OS requires the use of the following extended attributes.

3.3.4.5.4.1 MacVolumeInfo

This extended attribute contains Macintosh volume information which shall be stored as an *Implementation Use Extended Attribute* whose *ImplementationIdentifier* shall be set to:

"*UDF Mac VolumeInfo"

The *ImplementationUse* area for this extended attribute shall be structured as follows:

MacVolumeInfo format

RBP	Length	Name	Contents
0	2	Header Checksum	UInt16
2	12	Last Modification Date	timestamp
14	12	Last Backup Date	timestamp
26	32	Volume Finder Information	UInt32

The *MacVolumeInfo* extended attribute shall be recorded as an extended attribute of the root directory *FileEntry*.

3.3.4.5.4.2 MacFinderInfo

This extended attribute contains Macintosh Finder information for the associated file or directory. Since this information is accessed frequently, for performance reasons it *should* be recorded in the *ExtendedAttributes* field of the *FileEntry*.

The *MacFinderInfo* extended attribute shall be stored as an *Implementation Use Extended Attribute* whose *ImplementationIdentifier* shall be set to:

"*UDF Mac FinderInfo"

The *ImplementationUse* area for this extended attribute shall be structured as follows:

MacFinderInfo format for a directory

RBP	Length	Name	Contents
0	2	Header Checksum	UInt16
2	2	Reserved for padding (=0)	UInt16
4	4	Parent Directory ID	UInt32
8	16	Directory Information	UDFDInfo
24	16	Directory Extended Information	UDFDXInfo

MacFinderInfo format for a file

RBP	Length	Name	Contents
0	2	Header Checksum	UInt16
2	2	Reserved for padding (=0)	UInt16
4	4	Parent Directory ID	UInt32
8	16	File Information	UDFFInfo
24	16	File Extended Information	UDFFXInfo
40	4	Resource Fork Data Length	UInt32
44	4	Resource Fork Allocated Length	UInt32

The *MacFinderInfo* extended attribute shall be recorded as an extended attribute of every file and directory within the Logical Volume.

The following structures used within the *MacFinderInfo* structure are listed below for clarity. For complete information on these structures refer to the Macintosh books called "Inside Macintosh". The volume and page number listed with each structure correspond to a specific "Inside Macintosh" volume and page.

UDFPoint format (Volume I, page 139)

RBP	Length	Name	Contents
0	2	V	Int16
2	2	H	Int16

UDFRect format (Volume I, page 141)

RBP	Length	Name	Contents
0	2	Top	Int16
2	2	Left	Int16
4	2	Bottom	Int16
6	2	Right	Int16

UDFDInfo format (Volume IV, page 105)

RBP	Length	Name	Contents
0	8	FrRect	UDFRect
8	2	FrFlags	Int16
10	4	FrLocation	UDFPoint
14	2	FrView	Int16

UDFDXInfo format (Volume IV, page 106)

RBP	Length	Name	Contents
0	4	FrScroll	UDFPoint
4	4	FrOpenChain	Int32
8	1	FrScript	UInt8
9	1	FrXflags	UInt8
10	2	FrComment	Int16
12	4	FrPutAway	Int32

UDFFInfo format (Volume II, page 84)

RBP	Length	Name	Contents
0	4	FdType	UInt32
4	4	FdCreator	UInt32
8	2	FdFlags	UInt16
10	4	FdLocation	UDFPoint
14	2	FdFldr	Int16

UDFFXInfo format (Volume IV, page 105)

RBP	Length	Name	Contents
0	2	FdIconID	Int16
2	6	FdUnused	bytes
8	1	FdScript	Int8
9	1	FdXFlags	Int8
10	2	FdComment	Int16
12	4	FdPutAway	Int32

NOTE: The above mentioned structures have there original Macintosh names preceded by "UDF" to indicate that they are actually different from the original Macintosh structures. On the media the UDF structures are stored *little endian* as opposed to the original Macintosh structures which are in *big endian* format.

3.3.4.5.5 UNIX

- ☞ Ignored.
- ☞ Not supported. Extended attributes for existing files on the media shall be preserved.

3.3.4.6 Application Use Extended Attribute

```
struct ApplicationUseExtendedAttribute {          /* ECMA 167 4/14.10.9 */
    Uint32      AttributeType;    /* = 65536 */
    Uint8       AttributeSubtype;
    byte        Reserved[3];
    Uint32      AttributeLength;
    Uint32      ApplicationUseLength; /* (=AU_L) */
    struct EntityID ApplicationIdentifier;
    byte        ApplicationUse[AU_L];
}

```

The *AttributeLength* field specifies the length of the entire extended attribute. For variable length extended attributes defined using the *Application Use Extended Attribute* the *Attribute Length* field should be large enough to leave padding space between the end of the *ApplicationUse* field and the end of the *Application Use Extended Attribute*.

The structures defined in the following section contains a *header checksum* field. This field represents a 16-bit checksum of the Application Use Extended Attribute header. The fields *AttributeType* through *ApplicationIdentifier* inclusively represent the data covered by the *checksum*. The header *checksum* field is used to aid in disaster recovery of the extended attribute space. C source code for the header checksum may be found in the appendix.

NOTE: All compliant implementations shall preserve existing extended attributes encountered on the media. Implementations shall create and support the extended attributes for the operating system they currently support. For example, a Macintosh implementation shall preserve any OS/2 extended attributes encountered on the media. It shall also create and support all Macintosh extended attributes specified in this document.

3.3.4.6.1 All Operating Systems

This extended attribute shall be used to indicate unused space within the extended attribute space reserved for Application Use Extended Attributes. This extended attribute shall be stored as an *Application Use Extended Attribute* whose *ApplicationIdentifier* shall be set to:

"*UDF FreeAppEASpace"

The *ApplicationUse* area for this extended attribute shall be structured as follows:

FreeAppEASpace format

RBP	Length	Name	Contents
0	2	Header Checksum	Uint16
2	IU_L-1	Free EA Space	bytes

This extended attribute allows an implementation to shrink/grow the total size of other extended attributes without rewriting the complete extended attribute space. The *FreeAppEASpace* extended attribute may be overwritten and the space re-used by any implementation who sees a need to overwrite it.

3.3.5 Named Streams

Named streams provide a mechanism for associating related data of a file. It is similar in concept to extended attributes. However, named streams have significant advantages over extended attributes. They are not as limited in length. Space management is much easier as each stream has its own space, rather than the common space of extended attributes. Finding a particular stream does not involve searching the entire data space, as it does for extended attributes.

Named streams are mainly intended for user data. For example, a database application may store the records in the default or main stream and indices in named streams. The user would then see only one file for the database rather than many, and the application can use the various streams almost as if they were independent files.

Named Streams are identified by an Extended File Entry. Extended File Entries are required for files with associated named streams. Files without named streams should use Extended File Entries. Files may have normal File Entries; normal File Entries would be used where backward compatibility is desired, such as writing DVD Video discs.

There is a “*System Stream Directory*” which is the stream directory identified by the File Set Descriptor. These streams are used to describe data related to the entire medium instead of data that relates to a file. UDF defines several “*system streams*” that are to be identified by the system stream directory.

It is recommended that Named Streams be used to store metadata and application data instead of Extended Attributes in new implementations.

3.3.5.1 Named Streams Restrictions

ECMA 167 3rd edition defines a new File Entry that contains a field for identifying a stream directory. This new File Entry should be used in place of the old File Entry, and should be used for describing the streams themselves. Old and new file entries may be

freely mixed. In particular, compatibility with old reader implementations can be maintained for certain files.

Restrictions:

The stream directory ICB field of ICBs describing stream directories or named streams shall be set to zero. [no hierarchical streams]

Each named stream shall be identified by exactly one FID in exactly one Stream Directory. [no hard links among named streams or files and named streams]

Each Stream Directory ICB shall be identified by exactly one Stream Directory ICB field. [no hard links to stream directories]

Hard Links to files with named streams are allowed.

Named Streams and Stream Directories shall not have Extended Attributes.

The Unique ID field of Named Streams and Stream Directories shall be set to zero and shall be ignored when read. The Unique ID of a Named Stream or Stream Directory shall be considered to be the same as the Unique ID of the main data stream.

The UID, GID, and permissions fields of the main File Entry shall apply to all named streams associated with the main stream. At the time of creation of a named stream the values of the UID, GID and permissions fields of the main file entry should be used as the default values for the corresponding fields of the named stream. Implementations are not required to maintain or check these fields in a named stream.

Implementations should not present streams marked with the *metadata* bit set in the FID to the user. Streams marked with the *metadata* bit are intended solely for the use of the file system implementation.

The parent entry FID in a stream directory points to the main Extended File Entry, so its reference must be counted in the Link Count field of the Extended File Entry.

Note: There is a potential pitfall when deleting files/directories: if the link count goes to one when a FID is deleted, implementations must check for the presence of a stream directory. If present, there are no more FIDs pointing to this File Entry, so it and all associated structures must be deleted.

The modification time field of the main Extended File Entry should be updated whenever any associated named stream is modified. The Access Time field of the main Extended File Entry should be updated whenever any associated named stream is accessed. The

SETUID and SETGID bits of the ICB Tag flags field in the main Extended File Entry should be cleared whenever any associated named stream is modified.

The ICB for a Named Stream directory shall have a file type of 13. All named streams shall have a file type of 5.

All systems shall make the main data stream available, even on implementations that do not implement named streams.

3.3.5.2 System Named Streams (Metadata)

A set of named streams is defined by UDF for file system use. Some UDF named streams are identified by the File Set Descriptor and apply to the entire file set (*System Stream Directory*). Others pertain to individual files or directories and are identified by the stream directory.

All UDF named streams shall have the Metadata bit set in the File Identifier Descriptor in the Stream Directory, unless otherwise specified in this document. All streams not generated by the file system implementation shall have this bit set to zero.

All UDF named streams shall have a file type of 5 in the ICB identifying the stream.

The four characters *UDF are the first four characters of all UDF defined named streams in this document. Implementations shall not use any identifier beginning with *UDF for named streams that are not defined in this document. All identifiers for named streams beginning with *UDF are reserved for future definition by OSTA.

3.3.6 Extended Attributes as named streams

An extended attribute may be recorded as a named stream instead. The extended attribute is converted according to the following rules:

The stream is marked as a Metadata stream.

The EA header and Header Checksum are not recorded. If the EA included pad bytes between the Header Checksum and the remaining data, these are also not recorded.

Any extended attribute of a file or directory can be converted to a stream of the same file or directory by the following algorithm:

1. Create a stream for the file or directory containing the extended attribute. The identifier specified for the Entity Identifier becomes the stream name.
2. Copy the data of the extended attribute into the stream.

3. Delete the extended attribute.

3.3.7 UDF Defined System Streams

This section contains the definition of UDF defined system streams.

Stream Name	Stream Location	Metadata Flag
“*UDF Unique ID Mapping Data”	System Stream Directory (File Set Descriptor)	1
“*UDF Non-Allocatable Space”	System Stream Directory (File Set Descriptor)	1
“*UDF Power Cal Table”	System Stream Directory (File Set Descriptor)	1
“*UDF Backup”	System Stream Directory (File Set Descriptor)	1

Since the streams listed above have the Metadata flag set, the implementation shall not pass the name of the stream across the “plug-in file system interface” of a platform.

3.3.7.1 UniqueID Mapping Data Stream

The Unique ID Mapping Data allows an implementation to go directly to the ICB hierarchy for the file/directory associated with a UDFUniqueID, or to the ICB hierarchy for the directory which contains the file/directory associated with the UDFUniqueID. Unique ID Mapping Data is stored as a named stream of the *System Stream Directory* (associated with the File Set Descriptor). The name of this stream shall be set to:

“*UDF Unique ID Mapping Data”

The *Metadata* bit in the *File Characteristics* field of the File Identifier Descriptor shall be set to 1 to indicate that the existence of this file should not be made known to clients of a platform’s file system interface.

- shall be created for read-only media
- shall be created by implementations which batch write (e.g., pre-mastering tools) a volume on write-once and rewritable media
- for implementations which perform incremental updates of volumes on write-once or rewritable media (e.g., on-line file systems), the following rules apply:
 - may be created and maintained if not present
 - shall be maintained if present and volume is clean
 - should be repaired and maintained, but may be deleted, if present and volume is dirty
 - for these rules, a volume is clean if either a valid Close Logical Volume Integrity Descriptor or a valid Virtual Address Table is recorded

3.3.7.1.1 UDF Unique ID Mapping Data

UDF Unique ID Mapping Data

RBP	Length	Name	Contents
0	32	Implementation Identifier	EntityID
32	4	Flags	UInt32
36	4	Mapping Entry Count (=MEC)	UInt32
40	8	Reserved	Bytes (= #00)

Implementation Identifier is described in [cross reference to 2.1.5].

Flags are defined as follows:

Bit 0, If set to ONE, shall mean UDF Unique ID, once decremented by 16 (the value NextUniqueID is initialized to), can be used as an index into the array Mapping Entries. Blank entries, if present, are all beyond the last array element with a UDF Unique ID.

Bits 1 - 31, reserved, shall be set to ZERO.

Mapping Entry Count is the size, in entries, of the array Mapping Entries.

Mapping Entries is an array of UDF Unique ID Mapping Entry structures. There is one mapping entry for every non-stream, non-parent File Identifier Descriptor. Whenever the volume is consistent, the array is always sorted in ascending order of UDF Unique ID. Except as limited by the flags, blank entries are allowed anywhere in the array, and entries are not required to have a UDF Unique ID value of one more than the preceding entry. A blank entry has a value of ZERO in all fields.

3.3.7.1.2 UDF Unique ID Mapping Entry

The contents of the stream is described by the table “UDF Unique ID Mapping Data” which contains some header fields before an array of “UDF Unique ID Mapping Entry.” The fields of the structures are described below their corresponding table.

UDF Unique ID Mapping Entry

RBP	Length	Name	Contents
0	4	UDFUnique ID	UInt32
4	4	Parent Logical Block Number	UInt32
8	4	Object Logical Block Number	UInt32
12	2	Parent Partition Reference Number	UInt16
14	2	Object Partition Reference Number	UInt16

UDF Unique ID is the value found in a FID for the file or directory.

Parent Logical Block Number is the logical block number of the ICB identifying the directory that contains the FID identifying the object.

Object Logical Block Number is the logical block number of the ICB identifying this object.

Parent Partition Reference Number is the partition reference number from the long_ad of the ICB field in the parent in the same directory containing the FID for this file or directory.

Object Partition Reference Number is the partition reference number from the long_ad of the ICB field in the FID with this UDFUniqueID.

3.3.7.2 Non-Allocatable Space Stream

ECMA 167 does not provide for a mechanism to describe defective areas on media or areas not usable due to allocation outside of the file system. The *Non-Allocatable Space Stream* provides a method to describe space not usable by the file system. The *Non-Allocatable Space Stream* shall be recorded only on media systems that do not do defect management (eg. CD-RW).

The *Non-Allocatable Space Stream* shall be generated at format time. All space indicated by the *Non-Allocatable Space Stream* shall also be marked as allocated in the free space map. The *Non-Allocatable Space Stream* shall be recorded as a named stream in the system stream directory of the *File Set Descriptor*. The stream name shall be:

“*UDF Non-Allocatable Space”

The stream shall be marked with the attributes *Metadata* (bit 4 of file characteristics set to ONE) and *System* (bit 10 of ICB flags field set to ONE). This stream shall have all Non-Allocatable sectors identified by its allocation extents. The allocation extents shall indicate that each extent is allocated but not recorded. This list shall include both defective sectors found at format time and space allocated for sparing at format time.

3.3.7.3 Power Calibration Stream

One of the potential limitations on the effective use of the packet-write capabilities of CD-Recordable drives is the limited number (100) of power calibration areas available on current CD-R media. These power calibration areas are used to establish the appropriate power calibration settings with which data can be successfully and reliably written to the CD-R disc currently in the drive. The appropriate settings for a specific drive can vary significantly from disc to disc, between two different drives of the same make and model, and even using the same disc, drive and system configuration, but under different environmental conditions.

Because of this, most current CD-R drives recalibrate themselves the first time a write is attempted after a media change has occurred. This imposes no restriction on recording to discs using the disc-at-once or track-at-once modes, since in each of these modes the disc will fill (either by consuming the total available data capacity or total number of recordable tracks) in less than 100 separate writes. When using packet-write though, the disc could be written to thousands of times over an extended period before the disc is full.

Suppose, for instance, one wanted to incrementally back-up any new and/or modified files at the end of each work day (though the drive might also be used intermittently to do other projects during the day). These back-ups may require writing as little as a megabyte (or even less) each day. If one of the power calibration areas is used to calibrate the drive before writing to the disc every day, within five months the power calibration areas will all have been used, but only a small fraction of the total disc capacity will have been consumed. It is likely that such a result would be both unexpected and unacceptable to the user of such a product.

The industry is attempting to provide ways to reduce the frequency with which the power calibration area of a CD-Recordable disc must be used. At least one current CD-R drive model tries to remember the power calibration values last used for recording data on each of a small number of recently encountered discs. Most CD-Recordable drives provide a mechanism for the host software to retrieve from the drive the most recent power calibration settings used by the drive to record data on the current disc, and to restore and use such information at some future time.

The Power Calibration Table described herein would be used to store on the disc the power calibration information thus obtained for future use by compatible implementations. The table consists of a header followed by a list of records containing power calibration settings which have been used by various drives and/or hosts, under various conditions, to record data on this disc, as well as other relevant information which may be used to determine which of the recorded calibration settings may be appropriate for use in a future situation. While every effort has been made to anticipate and include all necessary information to make effective use of the recorded power calibration information possible, it is up to the individual implementation to determine if, when and how such information will actually be used.

The Power Calibration Table shall be recorded as a system stream of the File Set Descriptor according to the rules of 3.3.5. The name of the stream shall be as follows:

“*UDF Power Cal Table

Implementations that do not support the Power Calibration Table shall not delete this stream. Further, any implementation which supports and/or uses the Power Calibration Table shall not delete or modify any records from such table which the implementation, through its use thereof, did not clearly and specifically obsolete or update.

The stream shall be formatted as follows:

3.3.7.3.1 Power Calibration Table Stream

RBP	Length	Name	Contents
0	32	Implementation Identifier	EntityID [UDF 2.1.5]
32	4	Number of Records	Uint32 [1/7.1.5]
56	*	Power Calibration Table Records	bytes

Implementation Identifier:

See UDF section 2.1.5.

Number of Records:

Shall specify the number of records contained in the power calibration table

Power Calibration Table Records:

A series of power calibration table records for drives which have written to this disc. The length of this table is variable, but shall be a multiple of four bytes. Recording of data in any unstructured field shall be left-justified and padded on the right with #20 bytes.

Power Calibration Table Record Layout

RBP	Length	Name	Contents
0	2	Record Length	Uint16 [1/7.1.3]
2	2	Drive Unique Area Length [DUA_L]	Uint16 [1/7.1.3]
4	32	Vendor ID	bytes
36	16	Product ID	bytes
52	4	Firmware Revision Level	bytes
56	16	Serial Number/Device Unique ID	bytes
72	8	Host ID	bytes
80	12	Originating Time Stamp	Timestamp [1/7.3]
92	12	Updated Time Stamp	Timestamp [1/7.3]
104	2	Speed	Uint16 [1/7.1.3]
106	6	Power Calibration Values	bytes
112	[DUA_L]	Drive Unique Area	bytes

Record Length - The length of this Power Calibration Table Record in bytes, including the optional variable length Drive Unique Area. Shall be a multiple of four bytes.

Drive Unique Area Length - The length of the optional Drive Unique Area recorded at the end of this record in bytes. Shall be a multiple of four bytes.

Vendor ID - The Vendor ID reported by the drive.

Product ID - The Product ID reported by the drive.

Firmware Revision Level - The Firmware Revision Level reported by the drive.

Serial Number/Device Unique ID - A serial number or other unique identifier for the specific drive, of the model specified by the vendor and product IDs given, which has successfully used the power calibration values reported herein to record data on this disc.

Host ID - The host serial number, ethernet ID, or other value (or combination of values) used by an implementation to identify the specific host computer to which the drive was attached when it successfully used the power calibration values reported herein to record data on this disc. An implementation shall attempt to provide an unique value for each host, but is not required to guarantee the value's uniqueness.

Originating Time Stamp - The date and time at which the power calibration values recorded herein were initially verified to have been successfully used.

Updated Time Stamp - The date and time at which the power calibration values recorded herein were most recently verified to have been successfully used.

Speed - The recording speed, as reported by the drive, at which power calibration values recorded herein were successfully used. This value is the number of kilobytes per second (bytes per second / 1000) that the data was written to the disc by the drive (truncating any fractions). For example, a speed of 176 means data was written to the disc at 176 Kbytes/second, which is the basic CD-DA (Digital Audio) data rate (a.k.a. "1X" for CD-DA). A speed of 353 means data was written to the disc at 353 Kbytes/second, or twice the basic CD-DA data rate (a.k.a. "2X" for CD-DA). CD-ROM recording rates should be adjusted upward (roughly 15%) to the corresponding CD-DA rates to determine the correct speed value (eg. A "1X" CD-ROM data rate should be recorded as a "1X" CD-DA, which is a speed of 176). Note that these are raw data rates and do not reflect all overhead resulting from (additional) headers, error correction data, etc.

Power Calibration Values - The vendor-specific power calibration values reported by the drive.

Drive Unique Area - Optional area for recording unrestricted information unique to the drive (such as drive operating temperature) which certain implementations may use to enhance the use of the recorded power calibration information or the operation of the associated drive. Recording of data in this field shall be defined by the drive manufacturer. This area shall be an integral multiple of four bytes in length.

3.3.7.4 UDF Backup Time

The name of this stream shall be set to:

“*UDF Backup”

This stream shall have the following contents, which should be embedded in the ICB:

UDF Backup Time

RBP	Length	Name	Contents
0	12	Backup Time	timestamp

Backup Time is the latest time that a backup of this volume was performed.

3.3.8 UDF Defined Non-System Streams

This section defines the following non-system streams:

Stream Name	Stream Location	Metadata Flag
“*UDF Macintosh Resource Fork”	Any file or directory	0
“*UDF OS/2 EA”	Any file or directory	0
“*UDF NT ACL”	Any file or directory	0
“*UDF UNIX ACL”	Any file or directory	0

3.3.8.1 Macintosh Resource Fork Stream

Because the Resource Fork is referenced by an explicit interface, UDF implementations are not provided the authoritative name for this stream. For the purpose of interchange, the name shall be set to:

“*UDF Macintosh Resource Fork”

The *Metadata* bit in the *File Characteristics* field of the File Identifier Descriptor shall be set to 0 to indicate that the existence of this file should be made known to clients of a platform’s file system interface.

3.3.8.2 OS/2 EA Stream

All OS/2 definable extended attributes shall be stored as a named stream whose name shall be set to:

"*UDF OS/2 EA"

The *OS2EA Stream* contains a table of OS/2 Full EAs (*FEA*) as shown below.

FEA format

RBP	Length	Name	Contents
0	1	Flags	UInt8
1	1	Length of Name (=L_N)	UInt8
2	2	Length of Value (=L_V)	UInt16
4	L_N	Name	bytes
4+L_N	L_V	Value	bytes

For a complete description of Full EAs (*FEA*) please reference the following IBM document:

"Installable File System for OS/2 Version 2.0"
OS/2 File Systems Department
PSPC Boca Raton, Florida
February 17, 1992

3.3.8.3 Access Control Lists

Certain operating systems support the concept of Access Control Lists (ACLs) for enforcing file access restrictions. In order to facilitate support for ACL's UDF 2.0 will define a set of system level named streams, whose purpose will be to store the ACL associated with a given file object.

ACLs under UDF will be stored as named streams, following the rules of section 3.3.5. The contents of the named stream ACL shall be opaque and are not defined by this document. Interpretation of the contents of the named ACL shall be left to the operating system for which the ACL is intended. The following names will be used to identify the ACLs and shall be reserved. These names shall not be used for application named streams.

"*UDF NT ACL"

This name shall identify the named stream ACL for the Windows NT operating system.

"*UDF UNIX ACL"

This name shall identify the named stream ACL for the UNIX operating system.

4. User Interface Requirements

4.1 Part 3 - Volume Structure

Part 3 of ECMA 167 contains various Identifiers which, depending upon the implementation, may have to be presented to the user.

- *VolumeIdentifier*
- *VolumeSetIdentifier*
- *LogicalVolumeID*

These identifiers, which are stored in CS0, may have to go through some form of translation to be displayable to the user. Therefore when an implementation must perform an OS specific translation on the above listed identifiers the implementation shall use the algorithms described in section 4.1.2.1.

C source code for the translation algorithms may be found in the appendices of this document.

4.2 Part 4 - File System

4.2.1 ICB Tag

```
struct icbtag { /* ECMA 167 4/14.6 */
    Uint32    PriorRecordedNumberofDirectEntries;
    Uint16    StrategyType;
    byte      StrategyParameter[2];
    Uint16    NumberofEntries;
    byte      Reserved; /* == #00 */
    Uint8     FileType;
    Lb_addr   ParentICBLocation;
    Uint16    Flags;
}
```

4.2.1.1 FileType

Any open/close/read/write requests for file(s) that have any of the following values in this field shall result in an *Access Denied* error condition under non-UNIX operating system environments :

FileType values - 0 (Unknown), 6 (block device), 7 (character device), 9 (FIFO), and 10 (C_ISSOCK).

Any open/close/read/write requests to a file of type 12 (*SymbolicLink*) shall access the file/directory to which the symbolic link is pointing.

4.2.2 File Identifier Descriptor

```
struct FileIdentifierDescriptor {                               /* ECMA 167 4/14.4 */
    struct tag        DescriptorTag;
    Uint16            FileVersionNumber;
    Uint8             FileCharacteristics;
    Uint8             LengthOfFileIdentifier;
    struct long_ad    ICB;
    Uint16            LengthofImplementationUse;
    byte              ImplementationUse[];
    char              FileIdentifier[];
    byte              Padding[];
}
```

4.2.2.1 char FileIdentifier

Since most operating systems have their own specifications as to characteristics of a legal *FileIdentifier*, this becomes a problem with interchange. Therefore since all implementations must perform some form of *FileIdentifier* translation it would be to the users advantage if all implementations used the same algorithm.

The problems with *FileIdentifier* translations fall within one or more of the following categories:

- *Name Length* - Most operating systems have some fixed limit for the length of a file identifier.
- *Invalid Characters* - Most operating systems have certain characters considered as being illegal within a file identifier name.
- *Displayable Characters* - Since UDF supports the Unicode character set standard characters within a file identifier may be encountered which are not displayable on the receiving system.
- *Case Insensitive* - Some operating systems are case insensitive in regards to file identifiers. For example OS/2 preserves the original case of the file identifier when the file is created, but uses a case insensitive operations when accessing the file identifier. In OS/2 “Abc” and “ABC” would be the same file name.
- *Reserved Names* - Some operating systems have certain names that cannot be used for a file identifier name.

The following sections outline the *FileIdentifier* translation algorithm for each specific operating system covered by this document. This algorithm shall be used

by all OSTA UDF compliant implementations. The algorithm *only applies when reading* an illegal *FileIdentifier*. The original *FileIdentifier* name on the media should not be modified. This algorithm shall be applied by any implementation which performs some form of *FileIdentifier* translation to meet operating system file identifier restrictions.

All OSTA UDF compliant implementations shall support the UDF translation algorithms, but may support additional algorithms. If multiple algorithms are supported the user of the implementation shall be provided with a method to select the UDF translation algorithms. It is recommended that the default displayable algorithm be the UDF defined algorithm.

The primary goal of these algorithms is to produce a *unique* file name that meets the specific operating system restrictions without having to scan the entire directory in which the file resides.

C source code for the following algorithms may be found in the appendices of this document.

NOTE: In the definition of the following algorithms anytime a d-character is specified in quotes, the Unicode hexadecimal value will also be specified. In addition the following algorithms reference “CS0 Hex representation”, which corresponds to using the Unicode values #0030 - #0039, and #0041 - #0046 to represent a value in hex.

The following algorithms could still result in name-collisions being reported to the user of an implementation. However, the rationale includes the need for efficient access to the contents of a directory and consistent name translations across logical volume mounts and file system driver implementations, while allowing the user to obtain access to any file within the directory (through possibly renaming a file).

Definitions:

A *FileIdentifier* shall be considered as being composed of two parts, a *file name* and *file extension*.

The character '.' (#002E) shall be considered as the separator for the *FileIdentifier* of a file; characters appearing subsequent to the last '.' (#002E) shall be considered as constituting the *file extension* if and only if it is less than or equal to 5 characters in length, otherwise the *file extension* shall not exist. Characters appearing prior to the *file extension*, excluding the last '.' (#002E), shall be considered as constituting the *file name*.

NOTE: Even though OS/2, Macintosh, and UNIX do not have an official concept of a filename extension it is common file naming conventions to

end a file with “.” followed by a 1 to 5 character extension. Therefore the following algorithms attempt to preserve the *file extension* up to a maximum of 5 characters.

4.2.2.1.1 MS-DOS

Due to the restrictions imposed by the MS DOS operating system environments on the *FileIdentifier* associated with a file the following methodology shall be employed to handle *FileIdentifier(s)* under the above-mentioned operating system environments :

Restrictions: The *file name* component of the *FileIdentifier* shall not exceed 8 characters. The *file extension* component of the *FileIdentifier* shall not exceed 3 characters.

1. *FileIdentifier* Lookup: Upon request for a "*lookUp*" of a *FileIdentifier*, a case-insensitive comparison shall be performed.
2. Validate *FileIdentifier*: If the *FileIdentifier* is a valid MS-DOS file identifier then do not apply the following steps.
3. Remove Spaces: All embedded spaces within the identifier shall be removed.
4. Invalid Characters: A *FileIdentifier* that contains characters considered invalid within a *file name* or *file extension* (as defined above), or not displayable in the current environment, shall have them translated into "_" (#005F). (the file identifier on the media is NOT modified). Multiple sequential invalid or non-displayable characters shall be translated into a single "_" (#005F) character. Reference the appendix on invalid characters for a complete list.
5. Leading Periods: In the event that there do not exist any characters prior to the first "." (#002E) character, leading "." (#002E) characters shall be disregarded up to the first non "." (#002E) character, in the application of this heuristic.
6. Multiple Periods: In the event that the *FileIdentifier* contains multiple "." (#002E) characters, all characters appearing subsequent to the last '.' (#002E) shall be considered as constituting the *file extension* if and only if it is less than or equal to 5 characters in length, otherwise the *file extension* shall not exist. Characters appearing prior to the *file extension*, excluding the last '.' (#002E), shall be considered as constituting the *file name*. All embedded "." (#002E) characters within the *file name* shall be removed.
7. Long Extension: In the event that the number of characters constituting the *file extension* at this step in the process is greater than 3, the *file extension* shall be regarded as having been composed of the first 3 characters amongst the characters constituting the *file extension* at this step in the process.

8. Long Filename: In the event that the number of characters constituting the file name at this step in the process is greater than 8, the *file name* shall be truncated to 4 characters.
9. FileIdentifier CRC: Since through the above process character information from the original *FileIdentifier* is lost the chance of creating a duplicate *FileIdentifier* in the same directory increases. To greatly reduce the chance of having a duplicate *FileIdentifier* the file name shall be modified to contain a CRC of the original *FileIdentifier*. The *file name* shall be composed of the first 4 characters constituting the *file name* at this step in the process; followed by a 4 digit CS0 Hex representation of the 16-bit CRC of the original CS0 *FileIdentifier*.
NOTE: All other algorithms *except DOS* precede the CRC by a separator '#' (#0023). Due to the limited number of characters in a DOS file name a separator for the CRC is not used.
10. The new file identifier shall be translated to all upper case.

4.2.2.1.2 OS/2

Due to the restrictions imposed by the OS/2 operating system environment, on the *FileIdentifier* associated with a file the following methodology shall be employed to handle *FileIdentifier(s)* under the above-mentioned operating system environment:

1. FileIdentifier Lookup: Upon request for a "lookUp" of a *FileIdentifier*, a case-sensitive comparison may be performed. If the case-sensitive comparison is not done or if it fails, a case-insensitive comparison shall be performed.
2. Validate FileIdentifier: If the *FileIdentifier* is a valid OS/2 file identifier then do not apply the following steps.
3. Invalid Characters: A *FileIdentifier* that contains characters considered invalid within an OS/2 file name, or not displayable in the current environment shall have them translated into "_" (#005F). Multiple sequential invalid or non-displayable characters shall be translated into a single "_" (#005F) character. Reference the appendix on invalid characters for a complete list.
4. Trailing Periods and Spaces: All trailing "." (#002E) and " " (#0020) shall be removed.
5. FileIdentifier CRC: Since through the above process character information from the original *FileIdentifier* is lost the chance of creating a duplicate *FileIdentifier* in the same directory increases. To greatly reduce the chance of having a duplicate *FileIdentifier* the *file name* shall be modified to contain a CRC of the original *FileIdentifier*.

If there is a *file extension* then the new *FileIdentifier* shall be composed of up to the first (254 - (length of (new *file extension*) + 1 (for the '.')) - 5 (for the #CRC)) characters constituting the *file name* at

this step in the process, followed by the separator '#' (#0023); followed by a 4 digit CS0 Hex representation of the 16-bit CRC of the original CS0 *FileIdentifier*, followed by '.' (#002E) and the *file extension* at this step in the process.

Otherwise if there is no *file extension* the new *FileIdentifier* shall be composed of up to the first (254 - 5 (for the #CRC)) characters constituting the *file name* at this step in the process. Followed by the separator '#' (#0023); followed by a 4 digit CS0 Hex representation of the 16-bit CRC of the original CS0 *FileIdentifier*.

4.2.2.1.3 Macintosh

Due to the restrictions imposed by the Macintosh operating system environment, on the *FileIdentifier* associated with a file the following methodology shall be employed to handle *FileIdentifier(s)* under the above-mentioned operating system environment :

1. *FileIdentifier* Lookup: Upon request for a "*lookUp*" of a *FileIdentifier*, a case-sensitive comparison may be performed. If the case-sensitive comparison is not done or if it fails, a case-insensitive comparison shall be performed.
2. Validate *FileIdentifier*: If the *FileIdentifier* is a valid Macintosh file identifier then do not apply the following steps.
3. Invalid Characters: A *FileIdentifier* that contains characters considered invalid within a Macintosh file name, or not displayable in the current environment, shall have them translated into "_" (#005F). Multiple sequential invalid or non-displayable characters shall be translated into a single "_" (#005F) character. Reference the appendix on invalid characters for a complete list
4. Long *FileIdentifier* - In the event that the number of characters constituting the *FileIdentifier* at this step in the process is greater than 31 (maximum name length for the Macintosh operating system), the new *FileIdentifier* will consist of the first 26 characters of the *FileIdentifier* at this step in the process.
5. *FileIdentifier* CRC Since through the above process character information from the original *FileIdentifier* is lost the chance of creating a duplicate *FileIdentifier* in the same directory increases. To greatly reduce the chance of having a duplicate *FileIdentifier* the *file name* shall be modified to contain a CRC of the original *FileIdentifier*.

If there is a *file extension* then the new *FileIdentifier* shall be composed of up to the first (31 - (length of (new *file extension*) + 1 (for the '.')) - 5 (for the #CRC)) characters constituting the *file name* at this step in the process, followed by the separator '#' (#0023); followed by a 4 digit CS0 Hex representation of the 16-bit CRC of the original

CS0 *FileIdentifier*, followed by '.' (#002E) and the *file extension* at this step in the process.

Otherwise if there is no *file extension* the new *FileIdentifier* shall be composed of up to the first (31 - 5(for the #CRC)) characters constituting the *file name* at this step in the process. Followed by the separator '#' (#0023); followed by a 4 digit CS0 Hex representation of the 16-bit CRC of the original CS0 *FileIdentifier*.

4.2.2.1.4 Windows 95 & Windows NT

Due to the restrictions imposed by the Windows 95 and Windows NT operating system environments, on the *FileIdentifier* associated with a file the following methodology shall be employed to handle *FileIdentifier(s)* under the above-mentioned operating system environment:

1. *FileIdentifier Lookup*: Upon request for a "lookUp" of a *FileIdentifier*, a case-sensitive comparison may be performed. If the case-sensitive comparison is not done or if it fails, a case-insensitive comparison shall be performed.
2. *Validate FileIdentifier*: If the *FileIdentifier* is a valid file identifier for Windows 95 or Windows NT then do not apply the following steps.
3. *Invalid Characters*: A *FileIdentifier* that contains characters considered invalid within a file name of the supported operating system, or not displayable in the current environment shall have them translated into "_" (#005F). Multiple sequential invalid or non-displayable characters shall be translated into a single "_" (#005F) character. Reference the appendix on invalid characters for a complete list.
4. *Trailing Periods and Spaces*: All trailing "." (#002E) and " " (#0020) shall be removed.
5. *FileIdentifier CRC*: Since through the above process character information from the original *FileIdentifier* is lost the chance of creating a duplicate *FileIdentifier* in the same directory increases. To greatly reduce the chance of having a duplicate *FileIdentifier* the *file name* shall be modified to contain a CRC of the original *FileIdentifier*.

If there is a *file extension* then the new *FileIdentifier* shall be composed of up to the first (255 - (length of (new *file extension*) + 1 (for the '.')) - 5 (for the #CRC)) characters constituting the *file name* at this step in the process, followed by the separator '#' (#0023); followed by a 4 digit CS0 Hex representation of the 16-bit CRC of the original CS0 *FileIdentifier*, followed by '.' (#002E) and the *file extension* at this step in the process.

Otherwise if there is no *file extension* the new *FileIdentifier* shall be composed of up to the first (255 - 5 (for the #CRC)) characters

constituting the *file name* at this step in the process. Followed by the separator '#' (#0023); followed by a 4 digit CS0 Hex representation of the 16-bit CRC of the original CS0 *FileIdentifier*.

4.2.2.1.5 UNIX

Due to the restrictions imposed by UNIX operating system environments, on the *FileIdentifier* associated with a file the following methodology shall be employed to handle *FileIdentifier(s)* under the above-mentioned operating system environment:

1. *FileIdentifier* Lookup: Upon request for a "*lookUp*" of a *FileIdentifier*, a case-sensitive comparison shall be performed.
2. Validate *FileIdentifier*: If the *FileIdentifier* is a valid UNIX file identifier for the current system environment then do not apply the following steps.
3. Invalid Characters: A *FileIdentifier* that contains characters considered invalid within a UNIX file name for the current system environment, or not displayable in the current environment shall have them translated into "_" (#005E). Multiple sequential invalid or non-displayable characters shall be translated into a single "_" (#005E) character. Reference the appendix on invalid characters for a complete list
4. Long *FileIdentifier* - In the event that the number of characters constituting the *FileIdentifier* at this step in the process is greater than *MAXNameLength* (maximum name length for the specific UNIX operating system), the new *FileIdentifier* will consist of the first *MAXNameLength*-5 characters of the *FileIdentifier* at this step in the process.
5. *FileIdentifier* CRC Since through the above process character information from the original *FileIdentifier* is lost the chance of creating a duplicate *FileIdentifier* in the same directory increases. To greatly reduce the chance of having a duplicate *FileIdentifier* the *file name* shall be modified to contain a CRC of the original *FileIdentifier*.

If there is a *file extension* then the new *FileIdentifier* shall be composed of up to the first (*MAXNameLength* - (length of (new *file extension*) + 1 (for the '.')) - 5 (for the #CRC)) characters constituting the *file name* at this step in the process, followed by the separator '#' (#0023); followed by a 4 digit CS0 Hex representation of the 16-bit CRC of the original CS0 *FileIdentifier*, followed by '.' (#002E) and the *file extension* at this step in the process.

Otherwise if there is no *file extension* the new *FileIdentifier* shall be composed of up to the first (*MAXNameLength* - 5 (for the #CRC)) characters constituting the *file name* at this step in the process.

Followed by the separator '#' (#0023); followed by a 4 digit CS0 Hex representation of of the 16-bit CRC of the original CS0 *FileIdentifier*.

5. Informative

5.1 Descriptor Lengths

The following table summarizes the UDF limitations on the lengths of the Descriptors described in ECMA 167.

Descriptor	Length
Anchor Volume Descriptor Pointer	512
Volume Descriptor Pointer	512
Implementation Use Volume Descriptor	512
Partition Descriptor	512
Logical Volume Descriptor	no max
Unallocated Space Descriptor	no max
Terminating Descriptor	512
Logical Volume Integrity Descriptor	no max
File Set Descriptor	512
File Identifier Descriptor	Maximum of a Logical Block Size
Allocation Extent Descriptor	24
Indirect Entry	52
Terminal Entry	36
File Entry	Maximum of a Logical Block Size
Unallocated Space Entry	Maximum of a Logical Block Size
Space Bit Map Descriptor	no max
Partition Integrity Entry	N/A

5.2 Using Implementation Use Areas

5.2.1 Entity Identifiers

Refer to the section on *Entity Identifiers* defined earlier in this document.

5.2.2 Orphan Space

Orphan space may exist within a logical volume, but it is not recommended since it may be reallocated by some type of logical volume repair facility. Orphan space is defined as space that is not directly or indirectly referenced by any of the non-implementation use descriptors defined in ECMA 167.

NOTE: Any allocated extent for which the only reference resides within an implementation use field is considered orphan space.

5.3 Boot Descriptor

Please refer to the "OSTA Native Implementation Specification" document for information on the Boot Descriptor.

5.4 Technical Contacts

Technical questions regarding this document may be emailed to the *OSTA Technical Committee* at **info@osta.org**. Also technical questions may be faxed to the attention of the *OSTA Technical Committee* at 1-805-962-1542.

OSTA may also be contacted through the following address:

Technical Committee Chairman
OSTA
311 East Carrillo Street
Santa Barbara, CA 93101
(805) 963-3853

Also monitor the OSTA web site at **www.osta.org** for additional information.

6. Appendices

6.1 UDF Entity Identifier Definitions

Entity Identifier	Description
"*OSTA UDF Compliant"	Indicates the contents of the specified logical volume or file set is compliant with domain defined by this document.
"*UDF LV Info"	Contains additional Logical Volume identification information.
"*UDF FreeEASpace"	Contains free unused space within the implementation extended attribute space.
"*UDF FreeAppEASpace"	Contains free unused space within the application extended attribute space.
"*UDF DVD CGMS Info"	Contains DVD Copyright Management Information
"*UDF OS/2 EALength"	Contains OS/2 extended attribute length.
"*UDF Mac VolumeInfo"	Contains Macintosh volume information.
"*UDF Mac FinderInfo"	Contains Macintosh finder information.
"*UDF Virtual Partition"	Describes UDF Virtual Partition
"*UDF Sparable Partition"	Describes UDF Sparable Partition
"*UDF Virtual Alloc Tbl"	Contains information for handling rewriting to sequentially written media.
"*UDF Sparing Table"	Contains information for handling defective areas on the media

6.2 UDF Entity Identifier Values

Entity Identifier	Byte Value
"*OSTA UDF Compliant"	#2A, #4F, #53, #54, #41, #20, #55, #44, #46, #20, #43, #6F, #6D, #70, #6C, #69, #61, #6E, #74
""*UDF LV Info""	#2A, #55, #44, #46, #20, #4C, #56, #20, #49, #6E, #66, #6F
"*UDF FreeEASpace"	#2A, #55, #44, #46, #20, #46, #72, #65, #65, #45, #41, #53, #70, #61, #63, #65
"*UDF FreeAppEASpace"	#2A, #55, #44, #46, #20, #46, #72, #65, #65, #41, #70, #70, #45, #41, #53, #70, #61, #63, #65
""*UDF DVD CGMS Info""	#2A, #55, #44, #46, #20, #44, #56, #44, #20, #43, #47, #4D, #53, #20, #49, #6E, #66, #6F
"*UDF OS/2 EALength"	#2A, #55, #44, #46, #20, #45, #41, #4C, #65, #6E, #67, #74, #68
"*UDF Mac VolumeInfo"	#2A, #55, #44, #46, #20, #4D, #61, #63, #20, #56, #6F, #6C, #75, #6D, #65, #49, #6E, #66, #6F
"*UDF Mac FinderInfo"	#2A, #55, #44, #46, #20, #4D, #61, #63, #20, #49, #69, #6E, #64, #65, #72, #49, #6E, #66, #6F
""*UDF Virtual Partition""	#2A, #55, #44, #46, #20, #56, #69, #72, #74, #75, #61, #6C, #20, #50, #61, #72, #74, #69, #74, #69, #6F, #6E
""*UDF Sparable Partition""	#2A, #55, #44, #46, #20, #53, #70, #61, #72, #61, #62, #6C, #65, #20, #50, #61, #72, #74, #69, #74, #69, #6F, #6E
""*UDF Virtual Alloc Tbl""	#2A, #55, #44, #46, #20, #56, #69, #72, #74, #75, #61, #6C, #20, #41, #6C, #6C, #6F, #63, #20, #54, #62, #6C
""*UDF Sparing Table""	#2A, #55, #44, #46, #20, #53, #70, #61, #72, #69, #6E, #67, #20, #54, #61, #62, #6C, #65

6.3 Operating System Identifiers

The following tables define the current allowable values for the *OS Class* and *OS Identifier* fields in the *IdentifierSuffix* of Entity Identifiers.

The *OS Class* field will identify under which class of operating system the specified descriptor was recorded. The valid values for this field are as follows:

Value	Operating System Class
0	Undefined
1	DOS
2	OS/2
3	Macintosh OS
4	UNIX
5	Windows 9x
6	Windows NT
7-255	Reserved

The *OS Identifier* field will identify under which operating system the specified descriptor was recorded. The valid values for this field are as follows:

OS Class	OS Identifier	Operating System Identified
0	Any Value	Undefined
1	0	DOS/Windows 3.x
2	0	OS/2
3	0	Macintosh OS System 7
4	0	UNIX - Generic
4	1	UNIX - IBM AIX
4	2	UNIX - SUN OS / Solaris
4	3	UNIX - HP/UX
4	4	UNIX - Silicon Graphics Irix
4	5	UNIX - Linux
4	6	UNIX - MKLinux
4	7	UNIX - FreeBSD
5	0	Windows 95
6	0	Windows NT

For the most up to date list of values for OS Class and OS Identifier please contact OSTA and request a copy of the *UDF Entity Identifier Directory*. This directory will also contain Implementation Identifiers of ISVs who have provided the necessary information to OSTA.

NOTE: If you wish to add to this list please contact the OSTA Technical Committee Chairman at the OSTA address listed in section *5.3 Technical Contacts*.

6.4 OSTA Compressed Unicode Algorithm

```

/*****
 * OSTA compliant Unicode compression, uncompression routines.
 * Copyright 1995 Micro Design International, Inc.
 * Written by Jason M. Rinn.
 * Micro Design International gives permission for the free use of the
 * following source code.
 */
#include <stddef.h>

/*****
 * The following two typedef's are to remove compiler dependancies.
 * byte needs to be unsigned 8-bit, and unicode_t needs to be
 * unsigned 16-bit.
 */
typedef unsigned short unicode_t;
typedef unsigned char byte;

/*****
 * Takes an OSTA CS0 compressed unicode name, and converts
 * it to Unicode.
 * The Unicode output will be in the byte order
 * that the local compiler uses for 16-bit values.
 * NOTE: This routine only performs error checking on the compID.
 * It is up to the user to ensure that the unicode buffer is large
 * enough, and that the compressed unicode name is correct.
 *
 * RETURN VALUE
 *
 * The number of unicode characters which were uncompressed.
 * A -1 is returned if the compression ID is invalid.
 */
int UncompressUnicode(
int numberOfBytes, /* (Input) number of bytes read from media. */
byte *UDFCompressed, /* (Input) bytes read from media. */
unicode_t *unicode) /* (Output) uncompressed unicode characters. */
{
    unsigned int compID;
    int returnValue, unicodeIndex, byteIndex;

    /* Use UDFCompressed to store current byte being read. */
    compID = UDFCompressed[0];

    /* First check for valid compID. */
    if (compID != 8 && compID != 16)
    {
        returnValue = -1;
    }
    else
    {
        unicodeIndex = 0;
        byteIndex = 1;

        /* Loop through all the bytes. */
        while (byteIndex < numberOfBytes)
        {
            if (compID == 16)
            {
                /*Move the first byte to the high bits of the unicode char. */
                unicode[unicodeIndex] = UDFCompressed[byteIndex++] << 8;
            }
            else
            {
                unicode[unicodeIndex] = 0;
            }
            if (byteIndex < numberOfBytes)

```

```

        {
            /*Then the next byte to the low bits. */
            unicode[unicodeIndex] |= UDFCompressed[byteIndex++];
        }
        unicodeIndex++;
    }
    returnValue = unicodeIndex;
}
return(returnValue);
}

/*****
 * DESCRIPTION:
 * Takes a string of unicode wide characters and returns an OSTA CS0
 * compressed unicode string. The unicode MUST be in the byte order of
 * the compiler in order to obtain correct results. Returns an error
 * if the compression ID is invalid.
 *
 * NOTE: This routine assumes the implementation already knows, by
 * the local environment, how many bits are appropriate and
 * therefore does no checking to test if the input characters fit
 * into that number of bits or not.
 *
 * RETURN VALUE
 *
 * The total number of bytes in the compressed OSTA CS0 string,
 * including the compression ID.
 * A -1 is returned if the compression ID is invalid.
 */
int CompressUnicode(
int numberOfChars, /* (Input) number of unicode characters. */
int compID, /* (Input) compression ID to be used. */
unicode_t *unicode, /* (Input) unicode characters to compress. */
byte *UDFCompressed) /* (Output) compressed string, as bytes. */
{
    int byteIndex, unicodeIndex;

    if (compID != 8 && compID != 16)
    {
        byteIndex = -1; /* Unsupported compression ID ! */
    }
    else
    {
        /* Place compression code in first byte. */
        UDFCompressed[0] = compID;

        byteIndex = 1;
        unicodeIndex = 0;
        while (unicodeIndex < numberOfChars)
        {
            if (compID == 16)
            {
                /* First, place the high bits of the char
                 * into the byte stream.
                 */
                UDFCompressed[byteIndex++] =
                    (unicode[unicodeIndex] & 0xFF00) >> 8;
            }
            /*Then place the low bits into the stream. */
            UDFCompressed[byteIndex++] = unicode[unicodeIndex] & 0x00FF;
            unicodeIndex++;
        }
    }

    return(byteIndex);
}

```

6.5 CRC Calculation

The following C program may be used to calculate the CRC-CCITT checksum used in the TAG descriptors of ECMA 167.

```
/*
 *   CRC 010041
 */
static unsigned short crc_table[256] = {
    0x0000, 0x1021, 0x2042, 0x3063, 0x4084, 0x50A5, 0x60C6, 0x70E7,
    0x8108, 0x9129, 0xA14A, 0xB16B, 0xC18C, 0xD1AD, 0xE1CE, 0xF1EF,
    0x1231, 0x0210, 0x3273, 0x2252, 0x52B5, 0x4294, 0x72F7, 0x62D6,
    0x9339, 0x8318, 0xB37B, 0xA35A, 0xD3BD, 0xC39C, 0xF3FF, 0xE3DE,
    0x2462, 0x3443, 0x0420, 0x1401, 0x64E6, 0x74C7, 0x44A4, 0x5485,
    0xA56A, 0xB54B, 0x8528, 0x9509, 0xE5EE, 0xF5CF, 0xC5AC, 0xD58D,
    0x3653, 0x2672, 0x1611, 0x0630, 0x76D7, 0x66F6, 0x5695, 0x46B4,
    0xB75B, 0xA77A, 0x9719, 0x8738, 0xF7DF, 0xE7FE, 0xD79D, 0xC7BC,
    0x48C4, 0x58E5, 0x6886, 0x78A7, 0x0840, 0x1861, 0x2802, 0x3823,
    0xC9CC, 0xD9ED, 0xE98E, 0xF9AF, 0x8948, 0x9969, 0xA90A, 0xB92B,
    0x5AF5, 0x4AD4, 0x7AB7, 0x6A96, 0x1A71, 0x0A50, 0x3A33, 0x2A12,
    0xDBFD, 0xCBDC, 0xFBBF, 0xEB9E, 0x9B79, 0x8B58, 0xBB3B, 0xAB1A,
    0x6CA6, 0x7C87, 0x4CE4, 0x5CC5, 0x2C22, 0x3C03, 0x0C60, 0x1C41,
    0xEDAE, 0xFD8F, 0xCDEC, 0xDDCD, 0xAD2A, 0xBD0B, 0x8D68, 0x9D49,
    0x7E97, 0x6EB6, 0x5ED5, 0x4EF4, 0x3E13, 0x2E32, 0x1E51, 0x0E70,
    0xFF9F, 0xEFBE, 0xDFDD, 0xCFFC, 0xBF1B, 0xAF3A, 0x9F59, 0x8F78,
    0x9188, 0x81A9, 0xB1CA, 0xA1EB, 0xD10C, 0xC12D, 0xF14E, 0xE16F,
    0x1080, 0x00A1, 0x30C2, 0x20E3, 0x5004, 0x4025, 0x7046, 0x6067,
    0x83B9, 0x9398, 0xA3FB, 0xB3DA, 0xC33D, 0xD31C, 0xE37F, 0xF35E,
    0x02B1, 0x1290, 0x22F3, 0x32D2, 0x4235, 0x5214, 0x6277, 0x7256,
    0xB5EA, 0xA5CB, 0x95A8, 0x8589, 0xF56E, 0xE54F, 0xD52C, 0xC50D,
    0x34E2, 0x24C3, 0x14A0, 0x0481, 0x7466, 0x6447, 0x5424, 0x4405,
    0xA7DB, 0xB7FA, 0x8799, 0x97B8, 0xE75F, 0xF77E, 0xC71D, 0xD73C,
    0x26D3, 0x36F2, 0x0691, 0x16B0, 0x6657, 0x7676, 0x4615, 0x5634,
    0xD94C, 0xC96D, 0xF90E, 0xE92F, 0x99C8, 0x89E9, 0xB98A, 0xA9AB,
    0x5844, 0x4865, 0x7806, 0x6827, 0x18C0, 0x08E1, 0x3882, 0x28A3,
    0xCB7D, 0xDB5C, 0xEB3F, 0xFB1E, 0x8BF9, 0x9BD8, 0xABBB, 0xBB9A,
    0x4A75, 0x5A54, 0x6A37, 0x7A16, 0x0AF1, 0x1AD0, 0x2AB3, 0x3A92,
    0xFD2E, 0xED0F, 0xDD6C, 0xCD4D, 0xBDAA, 0xAD8B, 0x9DE8, 0x8DC9,
    0x7C26, 0x6C07, 0x5C64, 0x4C45, 0x3CA2, 0x2C83, 0x1CE0, 0x0CC1,
    0xEF1F, 0xFF3E, 0xCF5D, 0xDF7C, 0xAF9B, 0xBFBA, 0x8FD9, 0x9FF8,
    0x6E17, 0x7E36, 0x4E55, 0x5E74, 0x2E93, 0x3EB2, 0x0ED1, 0x1EF0
};

unsigned short
cksum(s, n)
    register unsigned char *s;
    register int n;
{
    register unsigned short crc=0;

    while (n-- > 0)
        crc = crc_table[(crc>>8 ^ *s++) & 0xff] ^ (crc<<8);

    return crc;
}

/* UNICODE Checksum */
unsigned short
unicode_cksum(s, n)
    register unsigned short *s;
    register int n;
{
    register unsigned short crc=0;
    while (n-- > 0) {
```

```

/* Take high order byte first--corresponds to a big endian byte stream. */
    crc = crc_table[(crc>>8 ^ (*s>>8) & 0xff) ^ (crc<<8)];
    crc = crc_table[(crc>>8 ^ (*s++ & 0xff) & 0xff) ^ (crc<<8)];
}
return crc;
}

#ifdef MAIN
unsigned char bytes[] = { 0x70, 0x6A, 0x77 };

main()
{
    unsigned short x;

    x = cksum(bytes, sizeof bytes);
    printf("checksum: calculated=%4.4x, correct=%4.4x\n", x, 0x3299);
    exit(0);
}
#endif

```

The CRC table in the previous listing was generated by the following program:

```
#include <stdio.h>

/*
 * a.out 010041 for CRC-CCITT
 */

main(argc, argv)
    int argc; char *argv[];
{
    unsigned long crc, poly;
    int n, i;

    sscanf(argv[1], "%lo", &poly);
    if(poly & 0xffff0000){
        fprintf(stderr, "polynomial is too large\n");
        exit(1);
    }

    printf("/*\n *      CRC 0%o\n */\n", poly);
    printf("static unsigned short crc_table[256] = {\n");
    for(n = 0; n < 256; n++){
        if(n % 8 == 0)
            printf(" ");
        crc = n << 8;
        for(i = 0; i < 8; i++){
            if(crc & 0x8000)
                crc = (crc << 1) ^ poly;
            else
                crc <<= 1;
            crc &= 0xFFFF;
        }
        if(n == 255)
            printf("0x%04X ", crc);
        else
            printf("0x%04X, ", crc);
        if(n % 8 == 7)
            printf("\n");
    }
    printf("};\n");
    exit(0);
}
```

All the above CRC code was devised by Don P. Mitchell of AT&T Bell Laboratories and Ned W. Rhodes of Software Systems Group.

It has been published in "Design and Validation of Computer Protocols," Prentice Hall, Englewood Cliffs, NJ, 1991, Chapter 3, ISBN 0-13-539925-4. Copyright is held by AT&T.

AT&T gives permission for the free use of the above source code.

6.6 Algorithm for Strategy Type 4096

This section describes a strategy for constructing an ICB hierarchy. For strategy type 4096 the root ICB hierarchy shall contain 1 direct entry and 1 indirect entry. To indicate that there is 1 direct entry a 1 shall be recorded as a Uint16 in the *StrategyParameter* field of the ICB Tag field. A value of 2 shall be recorded in the *MaximumNumberOfEntries* field of the ICB Tag field.

The indirect entry shall specify the address of another ICB which shall also contain 1 direct entry and 1 indirect entry, where the indirect entry specifies the address of another ICB of the same type. See the figure below:

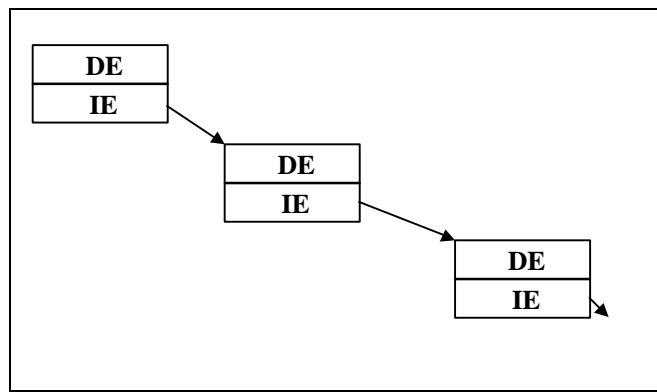

NOTE: This strategy builds an ICB hierarchy that is a simple linked list of direct entries.

6.7 Identifier Translation Algorithms

The following sample source code examples implement the file identifier translation algorithms described in this document.

The following basic algorithms may also be used to handle OS specific translations of the *VolumeIdentifier*, *VolumeSetIdentifier*, *LogicalVolumeID* and *FileSetID*.

6.7.1 DOS Algorithm

```
/*
*****
* OSTA UDF compliant file name translation routine for DOS.
* Copyright 1995 Micro Design International, Inc.
* Written by Jason M. Rinn.
* Micro Design International gives permission for the free use of the
* following source code.
*/

#include <stddef.h>

#define DOS_NAME_LEN      8
#define DOS_EXT_LEN      3
#define ILLEGAL_CHAR_MARK 0x005F
#define TRUE              1
#define FALSE             0
#define PERIOD            0x002E
#define SPACE             0x0020

/*
*****
* The following two typedef's are to remove compiler dependencies.
* byte needs to be unsigned 8-bit, and unicode_t needs to
* be unsigned 16-bit.
*/
typedef unsigned short unicode_t;
typedef unsigned char byte;

/** PROTOTYPES */
unsigned short unicode_cksum(register unsigned short *s, register int n);
int IsIllegal(unicode_t current);

/* Define functions or macros to both determine if a character
* is printable and compute the uppercase version of a character
* under your implementation.
*/
int UnicodeIsPrint(unicode_t);
unicode_t UnicodeToUpper(unicode_t);

/*
*****
* Translate udfName to dosName using OSTA compliant.
* dosName must be a unicode string with min length of 12.
*
* RETURN VALUE
*   Number of unicode characters in dosName.
*/
int UDFDOSName(
    unicode_t *dosName, /* (Output)DOS compatible name. */
    unicode_t *udfName, /* (Input) Name from UDF volume. */
    int udfLen) /* (Input) Length of UDF Name. */
{
    int index, dosIndex = 0, extIndex = 0, lastPeriodIndex;
    int needsCRC = FALSE, hasExt = FALSE, writingExt = FALSE;
```

```

unsigned short valueCRC;
unicode_t ext[DOS_EXT_LEN], current;

/*Used to convert hex digits. Used ASCII for readability. */
const char hexChar[] = "0123456789ABCDEF";

for (index = 0 ; index < udfLen ; index++)
{
    current = udfName[index];
    current = UnicodeToUpper(current);

    if (current == PERIOD)
    {
        if (dosIndex==0 || hasExt)
        {
            /* Ignore leading periods or any other than
             * used for extension.
             */
            needsCRC = TRUE;
        }
        else
        {
            /* First, find last character which is NOT a period
             * or space.
             */
            lastPeriodIndex = udfLen - 1;
            while(lastPeriodIndex >=0 &&
                (udfName[lastPeriodIndex]== PERIOD ||
                 udfName[lastPeriodIndex] == SPACE))
            {
                lastPeriodIndex--;
            }

            /* Now search for last remaining period. */
            while(lastPeriodIndex >= 0 &&
                udfName[lastPeriodIndex] != PERIOD)
            {
                lastPeriodIndex--;
            }

            /* See if the period we found was the last or not. */
            if (lastPeriodIndex != index)
            {
                needsCRC = TRUE; /* If not, name needs translation. */
            }

            /* As long as the period was not trailing,
             * the file name has an extension.
             */
            if (lastPeriodIndex >= 0)
            {
                hasExt = TRUE;
            }
        }
    }
}
else
{
    if ((!hasExt && dosIndex == DOS_NAME_LEN) ||
        extIndex == DOS_EXT_LEN)
    {
        /* File name or extension is too long for DOS. */
        needsCRC = TRUE;
    }
    else
    {
        if (current == SPACE) /* Ignore spaces. */

```

```

    {
        needsCRC = TRUE;
    }
else
{
    /* Look for illegal or unprintable characters. */
    if (IsIllegal(current) || !UnicodeIsPrint(current))
    {
        needsCRC = TRUE;
        current = ILLEGAL_CHAR_MARK;
        /* Skip Illegal characters(even spaces),
        * but not periods.
        */
        while(index+1 < udfLen
            && (IsIllegal(udfName[index+1])
                || !UnicodeIsPrint(udfName[index+1]))
            && udfName[index+1] != PERIOD)
        {
            index++;
        }

        /* Add current char to either file name or ext. */
        if (writingExt)
        {
            ext[extIndex++] = current;
        }
        else
        {
            dosName[dosIndex++] = current;
        }
    }
}
}
/* See if we are done with file name, either because we reached
* the end of the file name length, or the final period.
*/
if (!writingExt && hasExt && (dosIndex == DOS_NAME_LEN ||
    index == lastPeriodIndex))
{
    /* If so, and the name has an extension, start reading it. */
    writingExt = TRUE;
    /* Extension starts after last period. */
    index = lastPeriodIndex;
}
}

/*Now handle CRC if needed. */
if (needsCRC)
{
    /* Add CRC to end of file name or at position 4. */
    if (dosIndex > 4)
    {
        dosIndex = 4;
    }

    valueCRC = unicode_cksum(udfName, udfLen);

    /* Convert 16-bit CRC to hex characters. */
    dosName[dosIndex++] = hexChar[(valueCRC & 0xf000) >> 12];
    dosName[dosIndex++] = hexChar[(valueCRC & 0x0f00) >> 8];
    dosName[dosIndex++] = hexChar[(valueCRC & 0x00f0) >> 4];
    dosName[dosIndex++] = hexChar[(valueCRC & 0x000f)];
}

/* Add extension, if any. */
if (extIndex != 0)

```

```

    {
        dosName[dosIndex++] = PERIOD;
        for (index = 0; index < extIndex; index++)
        {
            dosName[dosIndex++] = ext[index];
        }
    }

    return(dosIndex);
}

/*****
 * Decides if a Unicode character matches one of a list
 * of ASCII characters.
 * Used by DOS version of IsIllegal for readability, since all of the
 * illegal characters above 0x0020 are in the ASCII subset of Unicode.
 * Works very similarly to the standard C function strchr().
 *
 * RETURN VALUE
 *
 * Non-zero if the Unicode character is in the given ASCII string.
 */
int UnicodeInString(
unsigned char *string, /* (Input) String to search through. */
unicode_t ch) /* (Input) Unicode char to search for. */
{
    int found = FALSE;
    while (*string != '\0' && found == FALSE)
    {
        /* These types should compare, since both are unsigned numbers. */
        if (*string == ch)
        {
            found = TRUE;
        }
        string++;
    }
    return(found);
}

/*****
 * Decides whether character passed is an illegal character for a
 * DOS file name.
 *
 * RETURN VALUE
 *
 * Non-zero if file character is illegal.
 */
int IsIllegal(
unicode_t ch) /* (Input) character to test. */
{
    /* Genuine illegal char's for DOS. */
    if (ch < 0x20 || UnicodeInString("\\\\/:*?\"<>|", ch))
    {
        return(1);
    }
    else
    {
        return(0);
    }
}

```

6.7.2 OS/2, Macintosh, Windows 95, Windows NT and UNIX Algorithm

```

/*****
 * OSTA UDF compliant file name translation routine for OS/2,
 * Windows 95, Windows NT, Macintosh and UNIX.
 * Copyright 1995 Micro Design International, Inc.
 * Written by Jason M. Rinn.
 * Micro Design International gives permission for the free use of the
 * following source code.
 */

/*****
 * To use these routines with different operating systems.
 *
 * OS/2
 *   Define OS2
 *   Define MAXLEN = 254
 *
 * Windows 95
 *   Define WIN_95
 *   Define MAXLEN = 255
 *
 * Windows NT
 *   Define WIN_NT
 *   Define MAXLEN = 255
 *
 * Macintosh:
 *   Define MAC.
 *   Define MAXLEN = 31.
 *
 * UNIX
 *   Define UNIX.
 *   Define MAXLEN as specified by unix version.
 */

#define ILLEGAL_CHAR_MARK 0x005F
#define CRC_MARK          0x0023
#define EXT_SIZE          5
#define TRUE              1
#define FALSE             0
#define PERIOD            0x002E
#define SPACE             0x0020

/*****
 * The following two typedef's are to remove compiler dependancies.
 * byte needs to be unsigned 8-bit, and unicode_t needs to
 * be unsigned 16-bit.
 */
typedef unsigned int unicode_t;
typedef unsigned char byte;

/**/
int IsIllegal(unicode_t ch);
unsigned short unicode_cksum(register unsigned short *s, register int n);

/* Define a function or macro which determines if a Unicode character is
 * printable under your implementation.
 */
int UnicodeIsPrint(unicode_t);

/*****
 * Translates a long file name to one using a MAXLEN and an illegal
 * char set in accord with the OSTA requirements. Assumes the name has
 * already been translated to Unicode.
 *
 * RETURN VALUE
 */

```

```

*
*   Number of unicode characters in translated name.
*/
int UDFTransName(
unicode_t *newName, /*(Output)Translated name. Must be of length MAXLEN*/
unicode_t *udfName, /* (Input) Name from UDF volume.*/
int udfLen,        /* (Input) Length of UDF Name. */
{
    int index, newIndex = 0, needsCRC = FALSE;
    int extIndex, newExtIndex = 0, hasExt = FALSE;
#ifdef (OS2 | WIN_95 | WIN_NT)
    int trailIndex = 0;
#endif
    unsigned short valueCRC;
    unicode_t current;
    const char hexChar[] = "0123456789ABCDEF";

    for (index = 0; index < udfLen; index++)
    {
        current = udfName[index];

        if (IsIllegal(current) || !UnicodeIsPrint(current))
        {
            needsCRC = TRUE;
            /* Replace Illegal and non-displayable chars with underscore. */
            current = ILLEGAL_CHAR_MARK;
            /* Skip any other illegal or non-displayable characters. */
            while(index+1 < udfLen && (IsIllegal(udfName[index+1])
                || !UnicodeIsPrint(udfName[index+1])))
            {
                index++;
            }
        }

        /* Record position of extension, if one is found. */
        if (current == PERIOD && (udfLen - index - 1) <= EXT_SIZE)
        {
            if (udfLen == index + 1)
            {
                /* A trailing period is NOT an extension. */
                hasExt = FALSE;
            }
            else
            {
                hasExt = TRUE;
                extIndex = index;
                newExtIndex = newIndex;
            }
        }
    }

#ifdef (OS2 | WIN_95 | WIN_NT)
    /* Record position of last char which is NOT period or space. */
    else if (current != PERIOD && current != SPACE)
    {
        trailIndex = newIndex;
    }
#endif

    if (newIndex < MAXLEN)
    {
        newName[newIndex++] = current;
    }
    else
    {
        needsCRC = TRUE;
    }
}

```

```

#ifdef (OS2 | WIN_95 | WIN_NT)
/* For OS2, 95 & NT, truncate any trailing periods and\or spaces. */
if (trailIndex != newIndex - 1)
{
    newIndex = trailIndex + 1;
    needsCRC = TRUE;
    hasExt = FALSE; /* Trailing period does not make an extension. */
}
#endif

if (needsCRC)
{
    unicode_t ext[EXT_SIZE];
    int localExtIndex = 0;
    if (hasExt)
    {
        int maxFilenameLen;
        /* Translate extension, and store it in ext. */
        for(index = 0; index < EXT_SIZE && extIndex + index + 1 < udfLen;
            index++ )
        {
            current = udfName[extIndex + index + 1];

            if (IsIllegal(current) || !UnicodeIsPrint(current))
            {
                needsCRC = 1;
                /* Replace Illegal and non-displayable chars
                 * with underscore.
                 */
                current = ILLEGAL_CHAR_MARK;
                /* Skip any other illegal or non-displayable
                 * characters.
                 */
                while(index + 1 < EXT_SIZE
                    && (IsIllegal(udfName[extIndex + index + 2])
                        || !isprint(udfName[extIndex + index + 2])))
                {
                    index++;
                }
            }
            ext[localExtIndex++] = current;
        }

        /* Truncate filename to leave room for extension and CRC. */
        maxFilenameLen = ((MAXLEN - 5) - localExtIndex - 1);
        if (newIndex > maxFilenameLen)
        {
            newIndex = maxFilenameLen;
        }
        else
        {
            newIndex = newExtIndex;
        }
    }
    else if (newIndex > MAXLEN - 5)
    {
        /*If no extension, make sure to leave room for CRC. */
        newIndex = MAXLEN - 5;
    }
    newName[newIndex++] = CRC_MARK; /* Add mark for CRC. */

    /*Calculate CRC from original filename from FileIdentifier. */
    valueCRC = unicode_cksum(udfName, udfLen);
    /* Convert 16-bits of CRC to hex characters. */
    newName[newIndex++] = hexChar[(valueCRC & 0xf000) >> 12];
    newName[newIndex++] = hexChar[(valueCRC & 0x0f00) >> 8];
}

```



```

        newName[newIndex++] = hexChar[(valueCRC & 0x00f0) >> 4];
        newName[newIndex++] = hexChar[(valueCRC & 0x000f)];

        /* Place a translated extension at end, if found. */
        if (hasExt)
        {
            newName[newIndex++] = PERIOD;
            for (index = 0; index < localExtIndex ; index++ )
            {
                newName[newIndex++] = ext[index];
            }
        }
        return(newIndex);
    }
}

#ifdef (OS2 | WIN_95 | WIN_NT)
/*****
 * Decides if a Unicode character matches one of a list
 * of ASCII characters.
 * Used by OS2 version of IsIllegal for readability, since all of the
 * illegal characters above 0x0020 are in the ASCII subset of Unicode.
 * Works very similarly to the standard C function strchr().
 *
 * RETURN VALUE
 *
 * Non-zero if the Unicode character is in the given ASCII string.
 */
int UnicodeInString(
unsigned char *string, /* (Input) String to search through. */
unicode_t ch) /* (Input) Unicode char to search for. */
{
    int found = FALSE;
    while (*string != '\0' && found == FALSE)
    {
        /* These types should compare, since both are unsigned numbers. */
        if (*string == ch)
        {
            found = TRUE;
        }
        string++;
    }
    return(found);
}
#endif /* OS2 */

/*****
 * Decides whether the given character is illegal for a given OS.
 *
 * RETURN VALUE
 *
 * Non-zero if char is illegal.
 */
int IsIllegal(unicode_t ch)
{
#ifdef MAC
    /* Only illegal character on the MAC is the colon. */
    if (ch == 0x003A)
    {
        return(1);
    }
    else
    {
        return(0);
    }
}
#endif

#ifdef defined UNIX

```

```

/* Illegal UNIX characters are NULL and slash. */
if (ch == 0x0000 || ch == 0x002F)
{
    return(1);
}
else
{
    return(0);
}

#elif defined (OS2 | WIN_95 | WIN_NT)
/* Illegal char's for OS/2 according to WARP toolkit. */
if (ch < 0x0020 || UnicodeInString("\\/:*?\"<>|", ch))
{
    return(1);
}
else
{
    return(0);
}
#endif
}

```

6.8 Extended Attribute Checksum Algorithm

```
/*
 * Calculates a 16-bit checksum of the Implementation Use
 * Extended Attribute header.  The fields AttributeType
 * through ImplementationIdentifier inclusively represent the
 * data covered by the checksum (48 bytes).
 */

Uint16 ComputeEAChecksum(byte *data)
{
    Uint16 checksum = 0;
    Uint    count;

    for( count = 0; count < 48; count++)
    {
        checksum += *data++;
    }

    return(checksum );
}
```

6.9 Requirements for DVD-ROM

This appendix defines the requirements and restrictions for UDF formatted DVD-ROM discs.

- DVD-ROM discs shall be mastered with the UDF file system
- DVD-ROM discs shall consist of a single volume and a single partition.

NOTE:. The disc may also include the ISO 9660 file system. If the disc contains both UDF and ISO 9660 file systems it shall be known as a *UDF Bridge* disc. This *UDF Bridge* disc will allow playing DVD-ROM media in computers which may only support ISO 9660. As UDF computer implementations are provided, the need for ISO 9660 will disappear, and future discs should contain only UDF.

If you intend to do any DVD development with UDF, please make sure that you fill out the OSTA UDF Developer Registration Form located in appendix 6.11. For planned operating system, check the *Other* box and write in DVD.

6.9.1 Constraints imposed by UDF for DVD-Video

This section describes the restrictions and requirements for UDF formatted DVD-Video discs for dedicated DVD content players. DVD-Video is one specific application of DVD-ROM using the UDF format for the home consumer market. Due to limited computing resources within a DVD player, restrictions and requirements were created so that a DVD player would not have to support every feature of the UDF specification.

All DVD-Video discs shall be mastered to contain all required data as specified by ECMA 167 (2nd edition) and UDF 1.02. This will ease playing of DVD-Video in computer systems. Examples of such data include the time, date, permission bits, and a free space map (indicating no free space). While DVD player implementations may ignore these fields, a UDF computer system implementation will not. Both entertainment-based and computer-based content can reside on the same disc.

NOTE: DVD-Video discs mastered according to UDF 2.00 may not be compatible with DVD-Video players. DVD-Video players expect media in UDF 1.02 format.

In an attempt to reduce code size and improve performance, all division described is integer arithmetic; all denominators shall be 2^n , such that all divisions may be carried out via logical shift operations.

- A DVD player shall only support UDF and not ISO 9660.
- Originating systems shall constrain individual files to be less than than or equal to 2^{30} - *Logical Block Size* bytes in length.

- The data of each file shall be recorded as a single extent. Each File Entry shall be recorded using the ICB Strategy Type 4.
- File and directory names shall be compressed as 8 bits per character using OSTA Compressed Unicode format .
- A DVD player shall not be required to follow symbolic links to any files.
- The DVD-Video files shall be stored in a subdirectory named "VIDEO_TS" directly under the root directory. Directory names are standardized in the *DVD Specifications for Read-Only Disc* document.

NOTE: The *DVD Specifications for Read-Only Disc* is a document, developed by the DVD Consortium, that describes the names of all DVD-Video files and a DVD-Video directory which will be stored on the media, and additionally describes the contents of the DVD-Video files.

- The file named "VIDEO_TS.IFO" in the VIDEO_TS subdirectory shall be read first.

All the above constraints apply only to the directory and files which the DVD player needs to access. There may be other files and directories on the media which are not intended for the DVD player and do not meet the above listed constraints. These other files and directories are ignored by the DVD player. This is what enables the ability to have both entertainment-based and computer-based content on the same disc.

6.9.2 How to read a UDF disc

This section describes the basic procedures that a DVD player would go through to read a UDF formatted DVD-Video disc.

6.9.2.1 Step 1. Volume Recognition Sequence

Find an ECMA 167 Descriptor in a volume recognition area which shall start at logical sector 16.

6.9.2.2 Step 2. Anchor Volume Descriptor Pointer

The Anchor Volume Descriptor Pointer which is located at an anchor point must be found. Duplicate anchor points shall be recorded at logical sector 256 and logical sector n, where n is the highest numbered logical sector on the disc.

A DVD player only needs to look at logical sector 256; the copy at logical sector n is redundant and only needed for defect tolerance. The Anchor Volume Descriptor Pointer contains three things of interest:

1. Static structures that may be used to identify and verify integrity of the disc.
2. Location of the Main Volume Descriptor Sequence (absolute logical sector number)
3. Length of the Main Volume Descriptor Sequence (bytes)

The data located in bytes 0-3 and 5 of the Anchor Volume Descriptor Pointer may be used for format verification if desired. Verifying the checksum in byte 4 and CRC in bytes 8-11 are good additional verifications to perform. MVDS_Location and MVDS_Length are read from this structure.

6.9.2.3 Step 3. Volume Descriptor Sequence

Read logical sectors:

MVDS_Location through MVDS_Location + (MVDS_Length - 1) / SectorSize

The logical sector size shall be 2048 bytes for DVD media. If this sequence can not be read, a Reserve Volume Descriptor Sequence should be read.

The Partition Descriptor shall be a descriptor with a tag identifier of 5. The partition number and partition location shall be recorded in logical sector number.

Partition_Location and Partition_Length are obtained from this structure.

The Logical Volume Descriptor shall be a descriptor with a tag identifier of 6. The location and length of the File Set Descriptor shall be recorded in the Logical Volume Descriptor.

FSD_Location, and FSD_Length are returned from this structure.

6.9.2.4 Step 4. File Set Descriptor

The File Set Descriptor is located at logical sector numbers:

Partition_Location + FSD_Location through
Partition_Location + FSD_Location + (FSD_Length - 1) / BlockSize

RootDir_Location and RootDir_Length shall be read from the File Set Descriptor in logical block number.

6.9.2.5 Step 5. Root Directory File Entry

RootDir_Location and RootDir_Length define the location of a File Entry. The File Entry describes the data space and permissions of the root directory.

The location and length of the Root Directory is returned.

6.9.2.6 Step 6. Root Directory

Parse the data in the root directory extent to find the VIDEO_TS subdirectory.

Find the VIDEO_TS File Identifier Descriptor. The name shall be in 8 bit compressed UDF format. Verify that VIDEO_TS is a directory.

Read the File Identifier Descriptor and find the location and length of a File Entry describing the VIDEO_TS directory.

6.9.2.7 Step 7. File Entry of VIDEO_TS

The File Entry found in the step above describes the data space and permissions of the VIDEO_TS directory.

The location and length of the VIDEO_TS directory is returned.

6.9.2.8 Step 8. VIDEO_TS directory

The extent found in the step above contains sets of File Identifier Descriptors. In this pass, verify that the entry points to a file and is named VIDEO_TS.IFO.

6.9.2.9 Step 9. File Entry of VIDEO_TS.IFO

The File Entry found in the step above describes the data space and permissions of the VIDEO_TS.IFO file.

The location and length of the VIDEO_TS.IFO file is returned.

Further files can be found in the same manner as the VIDEO_TS.IFO file when needed.

6.9.3 Obtaining DVD Documents

To obtain a copy of the *DVD Specifications for Read-Only Disc* document as well as other DVD related material, contact:

Toshiba Corporation
DVD Business Promotion & Support
DVD Products Division
Attn: Senior Manager
TEL: +81-3-3457-2473
FAX: +81-3-5444-9430

6.10 Recommendations for CD Media

CD Media (CD-R and CD-RW) requires special consideration due to its nature. CD was originally designed for read-only applications which affects the way in which it is written. The following guidelines are established to ensure interchange.

Each file and directory shall be described by a single direct ICB. The ICB should be written after the file data to allow for data underruns during writing, which will cause logical gaps in the file data. The ICB can be written afterward which will correctly identify all extents of the file data. The ICB shall be written in the data track, the file system track (if it exists), or both.

6.10.1 Use of UDF on CD-R media

ECMA 167 requires an Anchor Volume Descriptor Pointer (AVDP) at sector 256 and either N or $(N - 256)$, where n is the last recorded Physical Address on the media. UDF requires that the AVDP be recorded at both sector 256 and sector $(N - 256)$ when each session is closed (2.2.3). The file system may be in an intermediate state before closing and still be interchangeable, but not strictly in compliance with ECMA 167. In the intermediate state, only one AVDP exists. It should exist at sector 256, but if this is not possible due to a track reservation, it shall exist at sector 512.

Implementations should place file system control structures into virtual space and file data into real space. Reader implementations may cache the entire VAT; the size of the VAT should be considered by any UDF originating software. Computer based implementations are expected to handle VAT sizes of at least 64K bytes; dedicated player implementations may handle only smaller sizes.

The VAT may be located by using READ TRACK INFORMATION (for unfinished media) or READ TOC or READ CD RECORDED CAPACITY for finished media. See X3T10-1048D (SCSI-3 Multi Media Commands).

6.10.1.1 Requirements

- Writing shall use Mode 1 or Mode 2 Form 1 sectors. On one disc, either Mode 1 or Mode 2 Form 1 shall be used; a mixture of Mode 1 and Mode 2 Form 1 sectors on one disc is not allowed.
- If Mode 2 Form 1 is used, then the subheader bytes of all sectors used by the user data files and by the UDF structures shall have the following value:

File number = 0
Channel number = 0
Submode = 08h
Coding information = 0

- An intermediate state is allowed on CD-R media in which only one AVDP is recorded; this single AVDP shall be at sector 256 or sector 512 and according to the multisession rules below.
- Sequential file system writing shall be performed with variable packet writing. This allows maximum space efficiency for large and small updates. Variable packet writing is more compatible with CD-ROM drives as current models do not support method 2 addressing required by fixed packets.
- The Logical Volume Integrity descriptor shall be recorded and the volume marked as open. Logical volume integrity can be verified by finding the VAT ICB at the last recorded Physical Address. If the VAT ICB is present, the volume is clean; otherwise it is dirty.
- The Partition Header descriptor, if recorded, shall specify no Unallocated Space Table, no Unallocated Space Bitmap, no Partition Integrity Table, no Freed Space Table, and no Freed Space Bitmap. The drive is capable of reporting free space directly, eliminating the need for a separate descriptor.
- Each surface shall contain 0 or 1 read only partitions, 0 or 1 write once partitions, and 0 or 1 virtual partitions. CD media should contain 1 write once partition and 1 virtual partition.

6.10.1.2 “Bridge” formats

ISO 9660 requires a Primary Volume Descriptor (PVD) at sector 16. If an ISO 9660 file system is desired, it may contain references to the same files as those referenced by ECMA 167 structures, or reference a different set of files, or a combination of the two.

It is assumed that early implementations will record some ISO 9660 structures but that as implementations of UDF become available, the need for ISO 9660 structures will decrease.

If an ISO 9660 bridge disc contains Mode 2 Form 1 sectors, then the CD-ROM XA extensions of ISO 9660 must be used.

6.10.1.3 End of session data

A session is closed to enable reading by CD-ROM drives. The last complete session on the disc shall conform completely to ECMA 167 and have two AVDPs recorded. This shall be accomplished by writing data according to End of session data table below. Although not shown in the following example, the data may be written in multiple packets.

End of session data

Count	Description
1	Anchor Volume Descriptor Pointer
255	Implementation specific. May contain user data, file system structures, and/or link areas.
1	VAT ICB.

The implementation specific data may contain repeated copies of the VAT and VAT ICB. Compatibility with drives that do not accurately report the location of the last sector will be enhanced. Implementations shall ensure that enough space is available to record the end of session data. Recording the end of session data brings a volume into compliance with ECMA 167.

6.10.2 Use of UDF on CD-RW media

CD-RW media is randomly readable and block writable. This means that while any individual sector may be read, writing must occur in blocks containing multiple sectors. CD-RW systems do not provide for sparing of bad areas. Writing rules and sparing mechanisms have been defined.

6.10.2.1 Requirements

- Writing which conforms to this section of the standard shall be performed using fixed length packets.
- Writing shall be performed using Mode 1 or Mode 2, Form 1 sectors. On one disc, either Mode 1 or Mode 2 Form 1 shall be used.
- If Mode 2 Form 1 is used, then the subheader bytes of all sectors used by the user data files and by the UDF structures shall have the following value:

File number = 0

Channel number = 0

Submode = 08h

Coding information = 0

- The host shall perform read/modify/write to enable the apparent writing of single 2K sectors.
- The packet length shall be set when the disc is formatted. The packet length shall be 32 sectors (64 KB).
- The host shall maintain a list of defects on the disc using a Non-Allocatable Space List (see 3.3.7.1.2).
- Sparing shall be managed by the host via the sparing partition and a sparing table.
- Discs shall be formatted prior to use.

6.10.2.2 Formatting

Formatting shall consist of writing a lead-in, user data area, and lead-out. These areas may be written in any order. This physical format may be followed by a verification pass. Defects found during the verification pass shall be enumerated in the *Non-Allocatable Space* list (see 3.3.7.1.2). Finally, file system root structures shall be recorded. These mandatory file system and root structures include the Volume Recognition Sequence, Anchor Volume Descriptor Pointers, a Volume Descriptor Sequence, a File Set Descriptor and a Root Directory.

The Anchor Volume Descriptor Pointers shall be recorded at sectors 256 and $N - 256$, where N is the Physical Address of the last addressable sector.

Allocation for sparing shall occur during the format process. The sparing allocation may be zero in length.

The free space descriptors shall be recorded and shall reflect space allocated to defective areas and sector sparing areas.

The format may include all available space on the medium. However, if requested by the user, a subset may be formatted to save formatting time. That smaller format may be later “grown” to the full available space.

6.10.2.3 Growing the Format

If the medium is partially formatted, it may be later grown to a larger size. This operation consists of:

- Optionally erase the lead-in of the last session.
- Optionally erase the lead-out of the last session.
- Write packets beginning immediately after the last previously recorded packet.
- Update the sparing table to reflect any new spare areas
- Adjust the partition map as appropriate
- Update the free space map to show new available area
- Move the last AVDP to the new N - 256
- Write the lead-in (which reflects the new track size)
- Write the lead-out

6.10.2.4 Host Based Defect Management

The host shall perform defect management operations. The CD format was defined without any defect management; to be compatible with existing technology and components, the host must manage defects. There are two levels of defect management: Marking bad sectors at format time and on-line sparing. The host shall keep the tables on the media current.

6.10.2.5 Read Modify Write Operation

CD-RW media requires large writable units, as each unit incurs a 14KB overhead. The file system requires a 2KB writable unit. The difference in write sizes is handled by a read-modify-write operation by the host. An entire packet is read, the appropriate portions are modified, and the entire packet written to the CD.

Note that packets may not be aligned to 32 sector boundaries.

6.10.2.6 Levels of Compliance

6.10.2.6.1 Level 1

The disc shall be formatted with exactly one lead-in, program area, and lead-out. The program area shall contain exactly one track. The start of the partition shall be on a packet boundary. The partition length shall be an integral multiple of the packet size.

6.10.2.6.2 Level 2

The last session shall contain the UDF file system. All prior sessions shall be contained in one read-only partition.

6.10.2.6.3 Level 3

No restrictions shall apply.

6.10.3 Multisession and Mixed Mode

The Volume Recognition Sequence and Anchor Volume Descriptor Pointer locations are specified by ECMA 167 to be at a location relative to the beginning of the disc. The beginning of a disc shall be determined from a base address S for the purposes of finding the VRS and AVDP.

' S ' is the Physical Address of the first data sector in the first recorded data track in the last existent session of the volume. ' S ' is the same value currently used in multisession ISO 9660 recording. The first track in the session shall be a data track.

' N ' is the physical sector number of the last recorded data sector on a disc.

If random write mode is used, the media may be formatted with zero or one audio sessions followed by exactly one writable data session containing one track. Other session configurations are possible but not described here. There shall be no more than one writable partition or session at one time, and this session shall be the last session on the disc.

6.10.3.1 Volume Recognition Sequence

The following descriptions are added to UDF (see also ECMA 167 Part 2) in order to handle a multisession disc.

- The volume recognition area of the UDF Bridge format shall be the part of the volume space starting at sector $S + 16$.
- The volume recognition space shall end in the track in which it begins. As a result of this definition, the volume recognition area always exists in the last session of a disc.
- When recorded in Random Access mode, a duplicate Volume Recognition Sequence should be recorded beginning at sector $N - 16$.

6.10.3.2 Anchor Volume Descriptor Pointer

Anchor Volume Descriptor Pointers (AVDP) shall be recorded at the following logical sector numbers: $S + 256$ and $N - 256$. The AVDP at sector $N - 256$ shall be recorded before closing a session; it may not be recorded while a session is open.

6.10.3.3 UDF Bridge format

The UDF Bridge format allows UDF to be added to a disc that may contain another file system. A UDF Bridge disc shall contain a UDF file system in its last session. The last session shall follow the rules described in "Multisession and Mixed Mode" section above. The disc may contain sessions that are based on ISO 9660, audio, vendor unique, or a combination of file systems. The UDF Bridge format allows CD enhanced discs to be created.

A new Main and Reserve Volume Descriptor Sequence may exist in each added session, and may be different than earlier VDSs.

If the last session on a CD does not contain a valid UDF file system, the disc is not a UDF disc. Only the UDF structures in the last session, and any UDF structures and data referenced through them, are valid.

The UDF session may contain pointers to data or metadata in other sessions, pointers to data or metadata only within the UDF session, or a combination of both. Some examples of UDF Bridge discs are shown below.

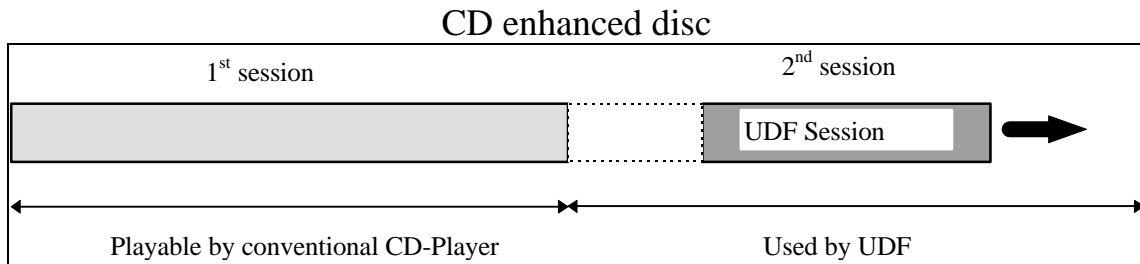
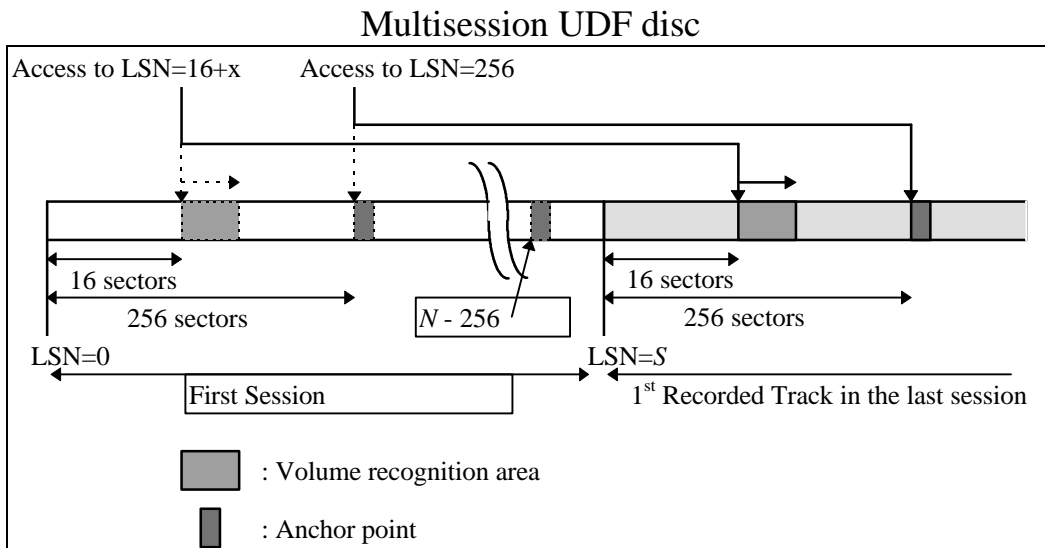

ISO 9660 converted to UDF

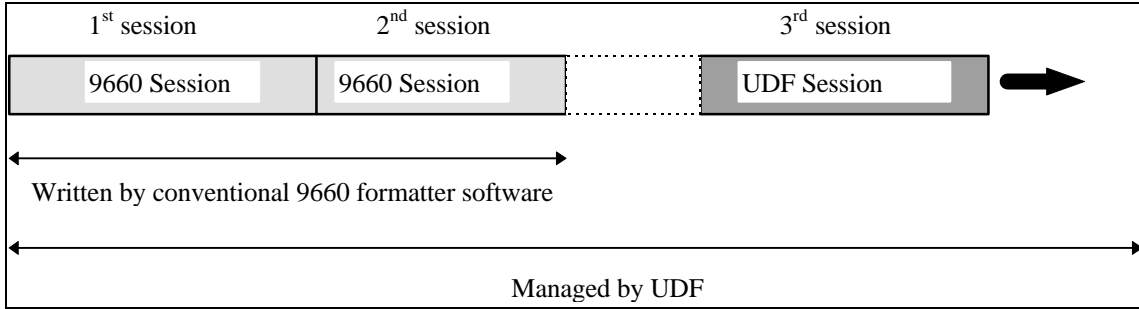

Foreign format converted to UDF

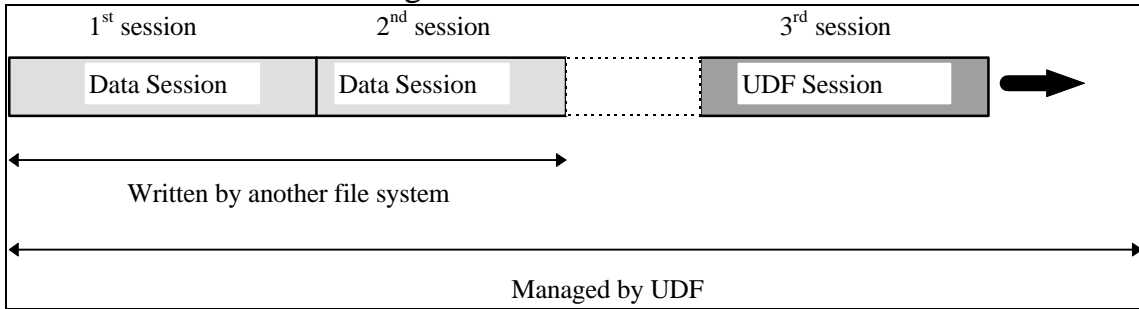

6.11 UDF Media Format Revision History

The following table shows when changes to the UDF Specification have taken place that affect the UDF format that can be recorded on a piece of media. The Document Change Notices (DCNs) which document a specific change are referenced in the table. The column *Update in UDF Revision* describes which revision of the UDF specification that the change was included. The fields *Minimum UDF Read Revision* and *Minimum UDF Write Revision* relate to the Revision Access Control fields described in 2.2.6.4.

Description	DCN	Updated in UDF Revision	Minimum UDF Read Revision	Minimum UDF Write Revision
Allocation Extent Descriptor	2-002	1.02	1.02	1.02
Path Component File Version Number	2-003	1.02	1.02	1.02
Parent Directory Entries	2-004	1.02	1.02	1.02
Device Specification Extended Attribute	2-005	1.02	1.01	1.02
Maximum Logical Extent Length	2-006	1.02	1.02	1.02
Unallocated Space Entry	2-008	1.02	1.01	1.02
DVD Copyright Management Information	2-009	1.02	1.02	1.02
Logical Volume Identifier	2-010	1.02	1.01	1.02
Extent Length Field of an Allocation Descriptor	2-012	1.02	1.01	1.02
Non-relocatable & Contiguous Flags	2-013	1.02	1.01	1.02
Revision of Requirements for DVD-ROM	2-014	1.02	1.02	1.02
Revision Access Control	2-015	1.02	1.01	1.02
Volume Set Identifier	2-017	1.02	1.01	1.02
UniqueIDs for Extended Attributes	2-018	1.02	1.02	1.02
Clarification of Dstrings	2-019	1.02	1.01	1.02
Application FreeEASpace Extended Attribute	2-020	1.02	1.02	1.02
Update of Identifier Suffix to 1.02	2-021	1.02	1.02	1.02
Update of Identifier Suffix to 1.50	2-025	1.50	1.50	1.50
Virtual Partition Map Entry	2-026	1.50	1.50	1.50
Allocation of Sparable Partition Map	2-027	1.50	1.50	1.50
Addition of Virtual Allocation Table	2-028	1.50	1.50	1.50
Addition of Sparing Table	2-029	1.50	1.50	1.50
Addition of Non-Allocatable Space List	2-030	1.50	1.02	1.50
Recommmendations for CD Media	2-031	1.50	1.50	1.50
Change 1.50 to 2.00	2-033	2.00	1.02	2.00
Clarified Domain flags	2-034	2.00	1.02	2.00
Unicode 2.0 Support	2-035	2.00	1.02	2.00
Named Streams	2-036	2.00	2.00	2.00
Unique ID Table as a Named Stream	2-037	2.00	1.02	2.00
Mac Resource Fork as a Named Stream	2-038	2.00	2.00	2.00
Location Field of the Extended Attribute Header	2-043	2.00	1.02	2.00
Access Control Lists	2-044	2.00	2.00	2.00
Descriptor Tags spanning block boundaries	2-047	2.00	1.02	2.00
Power Calibration Stream	2-048	2.00	1.02	2.00
Support for CD-R Multisession Required	2-050	2.00	1.50	2.00
Value of fields in LVID for virtual partition on CD-R	2-051	2.00	1.50	2.00
System stream to indicate volume backup time	2-055	2.00	2.00	2.00
New VAT	2-056	2.00	2.00	2.00
Restricting Virtual Addresses	2-057	2.00	1.50	2.00
File Times Extended Attribute	2-058	2.00	1.02	2.00
OS/2 EA Stream	2-061	2.00	2.00	2.00
Non-Allocatable Space Stream	2-062	2.00	1.02	2.00

6.12 Developer Registration Form

Any developer that plans on implementing ECMA 167 according to this document should complete the developer registration form on the following page. By becoming a registered OSTA developer you receive the following benefits:

- You will receive a list of the current OSTA registered developers and their associated *Implementation Identifiers*. The developers on this list are encouraged to interchange media to verify data interchange among implementations.
- Notification of OSTA Technical Committee meetings. You may attend a limited number of these meetings without becoming an official OSTA member.
- You can be added to the OSTA Technical Committee email reflector. This reflector provides you the opportunity to post technical questions on the *OSTA Universal Disk Format Specification*.
- You will receive an invitation to participate in the development of the next revision of this document.

For the latest information on OSTA and UDF visit the OSTA web site at the following address:

<http://www.osta.org>



OSTA Universal Disk Format Specification Developer Registration Form

Name: _____

Company: _____

Address: _____

City: _____

State/Province: _____

Zip/Postal Code: _____

Country: _____

Phone: _____ FAX: _____

Email: _____

Please indicate on which operating systems you plan to support UDF:

- DOS OS/2 Macintosh
 UNIX/POSIX Windows NT Windows 95
 Other _____

Please indicate which media types you plan to support:

- Magneto Optical WORM Phase Change
 CD-ROM CD-R CD-RW
 DVD-ROM DVD-R DVD-RAM DVD-Video
 DVD+RW
 Other _____

Please indicate what value you plan to use in the *Implementation Identifier* field of the *Entity Identifier* descriptor to identify your implementation:

NOTE: The identifier should be something that uniquely identifies your company as well as your product.

- Please add my email address to the OSTA Technical Committee email reflector.
 Please send an OSTA Membership kit.

*FAX Completed form to OSTA at 1-805-962-1541, or mail to:
OSTA, 311 E. Carrillo Street, Santa Barbara, CA 93101*

A

Access Control Lists, 77
ACL, 77
Allocation Descriptor, 8, 40, 45, 46
Allocation Extent Descriptor, 47
Anchor Volume Descriptor Pointer, 7, 19

C

CD-R, 2, 3, 4, 5, 27, 113, 114, 115, 117
CD-RW, 2, 113, 115
charspec, 10
Checksum, 60, 61, 62, 63, 66, 108
CRC, 16, 34, 45, 95, 97
CS0, 9, 10, 13, 18, 19, 20, 25, 36, 78, 80, 82

D

defect management, 27, 31, 117
Descriptor Tag, 16, 34, 45
Domain, 1, 12, 13, 14
DOS, 50, 51, 55, 61, 81, 91, 99, 100, 101, 102, 123
Dstrings, 10
DVD, 2, 60, 61, 89, 90, 109, 110, 111, 112, 121
DVD Copyright Management Information, 60, 61, 89, 121
DVD-Video, 109, 110

E

ECMA 167, 1
Entity Identifier, 7, 12, 17, 19, 20, 21, 23, 24, 35, 37, 39, 42, 43, 45, 53, 59, 65, 89, 90
Extended Attributes, 3, 24, 56, 57, 59, 60, 61, 62, 63, 65, 66, 89
extent, 21
Extent Length, 7, 121

F

File Entry, 8, 13, 42, 53
File Identifier Descriptor, 13, 38, 39, 50, 79
file set, 21
File Set Descriptor, 8, 13, 21, 34, 35, 37
File Set Descriptor Sequence, 21
FreeSpaceTable, 22

H

HardWriteProtect, 14, 21, 35, 37

I

ICB, 8, 38, 40, 50, 51, 56, 78, 79
ICB Tag, 8, 40, 51, 78
Implementation Use Volume Descriptor, 12, 24, 25, 87

ImplementationIdentifier, 17, 19, 20, 21, 24, 37, 42, 43, 45, 53, 59, 60, 61, 62, 65

L

Logical Block Size, 7, 8, 20
Logical Sector Size, 7
logical volume, 21
Logical Volume Descriptor, 8, 13, 20, 21, 23
Logical Volume Header Descriptor, 23, 49
Logical Volume Integrity Descriptor, 13, 21, 22, 45
LogicalVolumeIdentifier, 8

M

Macintosh, 3, 23, 24, 50, 52, 55, 56, 60, 62, 63, 64, 65, 80, 83, 89, 91, 103, 123
metadata, 35, 66, 67, 68
Metadata, 68, 70, 76

N

Non-Allocatable Space, 32, 33, 72, 116

O

Orphan Space, 87
OS/2, 3, 50, 51, 55, 60, 61, 65, 77, 79, 80, 82, 89, 90, 91, 103, 107, 123
Overwritable, 7

P

packet, 4, 6, 27, 28, 31, 32, 33, 114, 115, 116, 117
Partition Descriptor, 7, 12, 87, 111
Partition Header Descriptor, 37
Partition Integrity Entry, 8, 13, 45
Pathname, 47
power calibration, 72, 73, 74, 75, 76
Primary Volume Descriptor, 7, 12, 17

R

Read-Only, 7
Records, 8, 47
Rewritable, 7, 37, 46

S

SizeTable, 22
SoftWriteProtect, 14, 21, 37
Sparable Partition Map, 27
Sparing Table, 13, 28, 31, 32, 89, 90
strategy, 8, 35, 40
stream, 4, 47, 49, 66, 67, 68, 70, 71, 74, 76, 77, 94, 96
stream directory, 49, 66, 67, 68
streams, 2, 49, 66, 67, 68, 77
SymbolicLink, 78

T

TagSerialNumber, 16, 34
Timestamp, 7, 11, 22, 48

U

UDFUniqueID, 49, 70, 72
Unallocated Space Descriptor, 8, 22
Unicode, 9, 10, 79, 80, 93
UniqueID, 22, 42, 43, 49, 53, 56, 121
UNIX, 50, 52, 64, 85

V

VAT, 6, 27, 56, 113, 114, 115
Virtual Allocation Table, 6
virtual partition, 27, 114
Virtual Partition Map, 27
Volume Set, 7, 8, 17, 18, 24, 121

W

Windows, 50, 51, 61, 81
Windows 95, 50, 51, 84, 91, 123
Windows NT, 50, 51, 61, 84, 91, 103, 123
WORM, 7, 21, 35

OSTA Universal Disk Format Specification
Revision History

```
=====
2.00  04/03/98  Added support for Stream Files
           Added support for Access Control lists
           Added support for Power Calibration
1.50  02/04/97  Added support for CD-R Packet Writing
           Added support for CD-RW Packet Writing
           Added support for Windows 95
           Added limited support for Windows NT
           Incorporates Document Change Notices (DCN)
           DCN 2-025 through 2-033
1.02  10/30/96  Incorporates Document Change Notices (DCN)
           DCN2-001 through 2-024.
1.01  11/03/95  Added DVD Appendix and made a few
           minor editorial changes.
1.00  10/24/95  Original Release
```

```

/*****
 * OSTA compliant Unicode compression, uncompression routines.
 * Copyright 1995 Micro Design International, Inc.
 * Written by Jason M. Rinn.
 * Micro Design International gives permission for the free use of the
 * following source code.
 */
#include <stddef.h>

/*****
 * The following two typedef's are to remove compiler dependencies.
 * byte needs to be unsigned 8-bit, and unicode_t needs to be
 * unsigned 16-bit.
 */
typedef unsigned short unicode_t;
typedef unsigned char byte;

/*****
 * Takes an OSTA CS0 compressed unicode name, and converts
 * it to Unicode.
 * The Unicode output will be in the byte order
 * that the local compiler uses for 16-bit values.
 * NOTE: This routine only performs error checking on the compID.
 * It is up to the user to ensure that the unicode buffer is large
 * enough, and that the compressed unicode name is correct.
 *
 * RETURN VALUE
 *
 * The number of unicode characters which were uncompressed.
 * A -1 is returned if the compression ID is invalid.
 */
int UncompressUnicode(
int numberOfBytes, /* (Input) number of bytes read from media. */
byte *UDFCompressed, /* (Input) bytes read from media. */
unicode_t *unicode) /* (Output) uncompressed unicode characters. */
{
    unsigned int compID;
    int returnValue, unicodeIndex, byteIndex;

    /* Use UDFCompressed to store current byte being read. */
    compID = UDFCompressed[0];

    /* First check for valid compID. */
    if (compID != 8 && compID != 16)
    {
        returnValue = -1;
    }
    else
    {
        unicodeIndex = 0;
        byteIndex = 1;

        /* Loop through all the bytes. */
        while (byteIndex < numberOfBytes)
        {
            if (compID == 16)
            {

```

```

        /*Move the first byte to the high bits of the unicode char. */
        unicode[unicodeIndex] = UDFCompressed[byteIndex++] << 8;
    }
    else
    {
        unicode[unicodeIndex] = 0;
    }
    if (byteIndex < numberOfBytes)
    {
        /*Then the next byte to the low bits. */
        unicode[unicodeIndex] |= UDFCompressed[byteIndex++];
    }
    unicodeIndex++;
}
returnValue = unicodeIndex;
}
return(returnValue);
}

```

```

/*****

```

```

* DESCRIPTION:

```

```

* Takes a string of unicode wide characters and returns an OSTA CS0
* compressed unicode string. The unicode MUST be in the byte order of
* the compiler in order to obtain correct results. Returns an error
* if the compression ID is invalid.
*

```

```

* NOTE: This routine assumes the implementation already knows, by
* the local environment, how many bits are appropriate and
* therefore does no checking to test if the input characters fit
* into that number of bits or not.
*

```

```

* RETURN VALUE

```

```

* The total number of bytes in the compressed OSTA CS0 string,
* including the compression ID.
* A -1 is returned if the compression ID is invalid.
*/

```

```

int CompressUnicode(
int numberOfChars, /* (Input) number of unicode characters. */
int compID, /* (Input) compression ID to be used. */
unicode_t *unicode, /* (Input) unicode characters to compress. */
byte *UDFCompressed) /* (Output) compressed string, as bytes. */
{
    int byteIndex, unicodeIndex;

    if (compID != 8 && compID != 16)
    {
        byteIndex = -1; /* Unsupported compression ID ! */
    }
    else
    {
        /* Place compression code in first byte. */
        UDFCompressed[0] = compID;

        byteIndex = 1;
        unicodeIndex = 0;
    }
}

```

```
while (unicodeIndex < numberOfChars)
{
    if (compID == 16)
    {
        /* First, place the high bits of the char
        * into the byte stream.
        */
        UDFCompressed[byteIndex++] =
            (unicode[unicodeIndex] & 0xFF00) >> 8;
    }
    /*Then place the low bits into the stream. */
    UDFCompressed[byteIndex++] = unicode[unicodeIndex] & 0x00FF;
    unicodeIndex++;
}
}
return(byteIndex);
}
```



```

/*****
 * OSTA UDF compliant file name translation routine for DOS.
 * Copyright 1995 Micro Design International, Inc.
 * Written by Jason M. Rinn.
 * Micro Design International gives permission for the free use of the
 * following source code.
 */

#include <stddef.h>

#define DOS_NAME_LEN      8
#define DOS_EXT_LEN      3
#define ILLEGAL_CHAR_MARK 0x005F
#define TRUE              1
#define FALSE             0
#define PERIOD            0x002E
#define SPACE             0x0020

/*****
 * The following two typedef's are to remove compiler dependancies.
 * byte needs to be unsigned 8-bit, and unicode_t needs to
 * be unsigned 16-bit.
 */
typedef unsigned short unicode_t;
typedef unsigned char byte;

/**** PROTOTYPES ****/
unsigned short unicode_cksum(register unsigned short *s, register int n);
int IsIllegal(unicode_t current);

/* Define functions or macros to both determine if a character
 * is printable and compute the uppercase version of a character
 * under your implementation.
 */
int UnicodeIsPrint(unicode_t);
unicode_t UnicodeToUpper(unicode_t);

/*****
 * Translate udfName to dosName using OSTA compliant.
 * dosName must be a unicode string with min length of 12.
 *
 * RETURN VALUE
 *   Number of unicode characters in dosName.
 */
int UDFDOSName(
unicode_t *dosName, /* (Output)DOS compatible name. */
unicode_t *udfName, /* (Input) Name from UDF volume. */
int udfLen) /* (Input) Length of UDF Name. */
{
    int index, dosIndex = 0, extIndex = 0, lastPeriodIndex;
    int needsCRC = FALSE, hasExt = FALSE, writingExt = FALSE;
    unsigned short valueCRC;
    unicode_t ext[DOS_EXT_LEN], current;

    /*Used to convert hex digits. Used ASCII for readability. */
    const char hexChar[] = "0123456789ABCDEF";

```

```

for (index = 0 ; index < udfLen ; index++)
{
    current = udfName[index];
    current = UnicodeToUpper(current);

    if (current == PERIOD)
    {
        if (dosIndex==0 || hasExt)
        {
            /* Ignore leading periods or any other than
             * used for extension.
             */
            needsCRC = TRUE;
        }
        else
        {
            /* First, find last character which is NOT a period
             * or space.
             */
            lastPeriodIndex = udfLen - 1;
            while(lastPeriodIndex >=0 &&
                (udfName[lastPeriodIndex]== PERIOD ||
                 udfName[lastPeriodIndex] == SPACE))
            {
                lastPeriodIndex--;
            }

            /* Now search for last remaining period. */
            while(lastPeriodIndex >= 0 &&
                udfName[lastPeriodIndex] != PERIOD)
            {
                lastPeriodIndex--;
            }

            /* See if the period we found was the last or not. */
            if (lastPeriodIndex != index)
            {
                needsCRC = TRUE; /* If not, name needs translation. */
            }

            /* As long as the period was not trailing,
             * the file name has an extension.
             */
            if (lastPeriodIndex >= 0)
            {
                hasExt = TRUE;
            }
        }
    }
}
else
{
    if ((!hasExt && dosIndex == DOS_NAME_LEN) ||
        extIndex == DOS_EXT_LEN)
    {
        /* File name or extension is too long for DOS. */
        needsCRC = TRUE;
    }
}
}

```

```

    }
else
{
    if (current == SPACE) /* Ignore spaces. */
    {
        needsCRC = TRUE;
    }
    else
    {
        /* Look for illegal or unprintable characters. */
        if (IsIllegal(current) || !UnicodeIsPrint(current))
        {
            needsCRC = TRUE;
            current = ILLEGAL_CHAR_MARK;
            /* Skip Illegal characters (even spaces),
             * but not periods.
             */
            while(index+1 < udfLen
                && (IsIllegal(udfName[index+1])
                    || !UnicodeIsPrint(udfName[index+1]))
                && udfName[index+1] != PERIOD)
            {
                index++;
            }
        }

        /* Add current char to either file name or ext. */
        if (writingExt)
        {
            ext[extIndex++] = current;
        }
        else
        {
            dosName[dosIndex++] = current;
        }
    }
}
}

/* See if we are done with file name, either because we reached
 * the end of the file name length, or the final period.
 */
if (!writingExt && hasExt && (dosIndex == DOS_NAME_LEN ||
    index == lastPeriodIndex))
{
    /* If so, and the name has an extension, start reading it. */
    writingExt = TRUE;
    /* Extension starts after last period. */
    index = lastPeriodIndex;
}
}

/*Now handle CRC if needed. */
if (needsCRC)
{
    /* Add CRC to end of file name or at position 4. */
    if (dosIndex >4)
    {

```

```

        dosIndex = 4;
    }

    valueCRC = unicode_cksum(udfName, udfLen);

    /* Convert 16-bit CRC to hex characters. */
    dosName[dosIndex++] = hexChar[(valueCRC & 0xf000) >> 12];
    dosName[dosIndex++] = hexChar[(valueCRC & 0x0f00) >> 8];
    dosName[dosIndex++] = hexChar[(valueCRC & 0x00f0) >> 4];
    dosName[dosIndex++] = hexChar[(valueCRC & 0x000f)];
}

/* Add extension, if any. */
if (extIndex != 0)
{
    dosName[dosIndex++] = PERIOD;
    for (index = 0; index < extIndex; index++)
    {
        dosName[dosIndex++] = ext[index];
    }
}

return(dosIndex);
}

/*****
* Decides if a Unicode character matches one of a list
* of ASCII characters.
* Used by DOS version of IsIllegal for readability, since all of the
* illegal characters above 0x0020 are in the ASCII subset of Unicode.
* Works very similarly to the standard C function strchr().
*
* RETURN VALUE
*
* Non-zero if the Unicode character is in the given ASCII string.
*/
int UnicodeInString(
unsigned char *string, /* (Input) String to search through. */
unicode_t ch) /* (Input) Unicode char to search for. */
{
    int found = FALSE;
    while (*string != '\\0' && found == FALSE)
    {
        /* These types should compare, since both are unsigned numbers. */
        if (*string == ch)
        {
            found = TRUE;
        }
        string++;
    }
    return(found);
}

/*****
* Decides whether character passed is an illegal character for a
* DOS file name.
*

```

```
* RETURN VALUE
*
*   Non-zero if file character is illegal.
*/
int IsIllegal(
unicode_t ch) /* (Input) character to test. */
{
    /* Genuine illegal char's for DOS. */
    if (ch < 0x20 || UnicodeInString("\\/:*?\"<>|", ch))
    {
        return(1);
    }
    else
    {
        return(0);
    }
}
```

```

/*****
 * OSTA UDF compliant file name translation routine for OS/2,
 * Windows 95, Windows NT, Macintosh and UNIX.
 * Copyright 1995 Micro Design International, Inc.
 * Written by Jason M. Rinn.
 * Micro Design International gives permission for the free use of the
 * following source code.
 */

/*****
 * To use these routines with different operating systems.
 *
 * OS/2
 *   Define OS2
 *   Define MAXLEN = 254
 *
 * Windows 95
 *   Define WIN_95
 *   Define MAXLEN = 255
 *
 * Windows NT
 *   Define WIN_NT
 *   Define MAXLEN = 255
 *
 * Macintosh:
 *   Define MAC.
 *   Define MAXLEN = 31.
 *
 * UNIX
 *   Define UNIX.
 *   Define MAXLEN as specified by unix version.
 */

#define ILLEGAL_CHAR_MARK 0x005F
#define CRC_MARK          0x0023
#define EXT_SIZE          5
#define TRUE              1
#define FALSE             0
#define PERIOD            0x002E
#define SPACE             0x0020

/*****
 * The following two typedef's are to remove compiler dependancies.
 * byte needs to be unsigned 8-bit, and unicode_t needs to
 * be unsigned 16-bit.
 */
typedef unsigned int unicode_t;
typedef unsigned char byte;

/**** PROTOTYPES ****/
int IsIllegal(unicode_t ch);
unsigned short unicode_cksum(register unsigned short *s, register int n);

/* Define a function or macro which determines if a Unicode character is
 * printable under your implementation.
 */
int UnicodeIsPrint(unicode_t);

```

```

/*****
 * Translates a long file name to one using a MAXLEN and an illegal
 * char set in accord with the OSTA requirements. Assumes the name has
 * already been translated to Unicode.
 *
 * RETURN VALUE
 *
 *   Number of unicode characters in translated name.
 */
int UDFTransName(
unicode_t *newName, /*(Output)Translated name. Must be of length MAXLEN*/
unicode_t *udfName, /* (Input) Name from UDF volume.*/
int udfLen,        /* (Input) Length of UDF Name. */
{
    int index, newIndex = 0, needsCRC = FALSE;
    int extIndex, newExtIndex = 0, hasExt = FALSE;
#ifdef (OS2 | WIN_95 | WIN_NT)
    int trailIndex = 0;
#endif
    unsigned short valueCRC;
    unicode_t current;
    const char hexChar[] = "0123456789ABCDEF";

    for (index = 0; index < udfLen; index++)
    {
        current = udfName[index];

        if (IsIllegal(current) || !UnicodeIsPrint(current))
        {
            needsCRC = TRUE;
            /* Replace Illegal and non-displayable chars with underscore. */
            current = ILLEGAL_CHAR_MARK;
            /* Skip any other illegal or non-displayable characters. */
            while(index+1 < udfLen && (IsIllegal(udfName[index+1])
                || !UnicodeIsPrint(udfName[index+1])))
            {
                index++;
            }
        }

        /* Record position of extension, if one is found. */
        if (current == PERIOD && (udfLen - index - 1) <= EXT_SIZE)
        {
            if (udfLen == index + 1)
            {
                /* A trailing period is NOT an extension. */
                hasExt = FALSE;
            }
            else
            {
                hasExt = TRUE;
                extIndex = index;
                newExtIndex = newIndex;
            }
        }
    }

#ifdef (OS2 | WIN_95 | WIN_NT)
    /* Record position of last char which is NOT period or space. */
    else if (current != PERIOD && current != SPACE)

```

```

        {
            trailIndex = newIndex;
        }
#endif

        if (newIndex < MAXLEN)
        {
            newName[newIndex++] = current;
        }
        else
        {
            needsCRC = TRUE;
        }
    }

#ifdef (OS2 | WIN_95 | WIN_NT)
    /* For OS2, 95 & NT, truncate any trailing periods and/or spaces. */
    if (trailIndex != newIndex - 1)
    {
        newIndex = trailIndex + 1;
        needsCRC = TRUE;
        hasExt = FALSE; /* Trailing period does not make an extension. */
    }
#endif

    if (needsCRC)
    {
        unicode_t ext[EXT_SIZE];
        int localExtIndex = 0;
        if (hasExt)
        {
            int maxFilenameLen;
            /* Translate extension, and store it in ext. */
            for(index = 0; index < EXT_SIZE && extIndex + index + 1 < udfLen;
                index++ )
            {
                current = udfName[extIndex + index + 1];

                if (IsIllegal(current) || !UnicodeIsPrint(current))
                {
                    needsCRC = 1;
                    /* Replace Illegal and non-displayable chars
                     * with underscore.
                     */
                    current = ILLEGAL_CHAR_MARK;
                    /* Skip any other illegal or non-displayable
                     * characters.
                     */
                    while(index + 1 < EXT_SIZE
                        && (IsIllegal(udfName[extIndex + index + 2])
                            || !isprint(udfName[extIndex + index + 2])))
                    {
                        index++;
                    }
                }
                ext[localExtIndex++] = current;
            }

            /* Truncate filename to leave room for extension and CRC. */

```



```

        maxFilenameLen = ((MAXLEN - 5) - localExtIndex - 1);
        if (newIndex > maxFilenameLen)
        {
            newIndex = maxFilenameLen;
        }
        else
        {
            newIndex = newExtIndex;
        }
    }
else if (newIndex > MAXLEN - 5)
{
    /*If no extension, make sure to leave room for CRC. */
    newIndex = MAXLEN - 5;
}
newName[newIndex++] = CRC_MARK; /* Add mark for CRC. */

/*Calculate CRC from original filename from FileIdentifier. */
valueCRC = unicode_cksum(udfName, udfLen);
/* Convert 16-bits of CRC to hex characters. */
newName[newIndex++] = hexChar[(valueCRC & 0xf000) >> 12];
newName[newIndex++] = hexChar[(valueCRC & 0x0f00) >> 8];
newName[newIndex++] = hexChar[(valueCRC & 0x00f0) >> 4];
newName[newIndex++] = hexChar[(valueCRC & 0x000f)];

/* Place a translated extension at end, if found. */
if (hasExt)
{
    newName[newIndex++] = PERIOD;
    for (index = 0; index < localExtIndex ; index++ )
    {
        newName[newIndex++] = ext[index];
    }
}
}
return(newIndex);
}

#ifdef (OS2 | WIN_95 | WIN_NT)
/*****
 * Decides if a Unicode character matches one of a list
 * of ASCII characters.
 * Used by OS2 version of IsIllegal for readability, since all of the
 * illegal characters above 0x0020 are in the ASCII subset of Unicode.
 * Works very similarly to the standard C function strchr().
 *
 * RETURN VALUE
 *
 * Non-zero if the Unicode character is in the given ASCII string.
 */
int UnicodeInString(
unsigned char *string, /* (Input) String to search through. */
unicode_t ch) /* (Input) Unicode char to search for. */
{
    int found = FALSE;
    while (*string != '\0' && found == FALSE)
    {
        /* These types should compare, since both are unsigned numbers. */
        if (*string == ch)

```

```

        {
            found = TRUE;
        }
        string++;
    }
    return(found);
}
#endif /* OS2 */

/*****
 * Decides whether the given character is illegal for a given OS.
 *
 * RETURN VALUE
 *
 * Non-zero if char is illegal.
 */
int IsIllegal(unicode_t ch)
{
#ifdef MAC
    /* Only illegal character on the MAC is the colon. */
    if (ch == 0x003A)
    {
        return(1);
    }
    else
    {
        return(0);
    }
}

#elif defined UNIX
    /* Illegal UNIX characters are NULL and slash. */
    if (ch == 0x0000 || ch == 0x002F)
    {
        return(1);
    }
    else
    {
        return(0);
    }
}

#elif defined (OS2 | WIN_95 | WIN_NT)
    /* Illegal char's for OS/2 according to WARP toolkit. */
    if (ch < 0x0020 || UnicodeInString("\\/:*?\"<>|", ch))
    {
        return(1);
    }
    else
    {
        return(0);
    }
}
#endif
}

```

UDF Specification v2.00 - A specification describing the Universal Disk Format developed by the Optical Storage Technology Association (OSTA). This specification is for developers who plan to implement UDF which is based upon the ISO 13346 standard. UDF is a file system format standard that enables file interchange among different operating systems.